

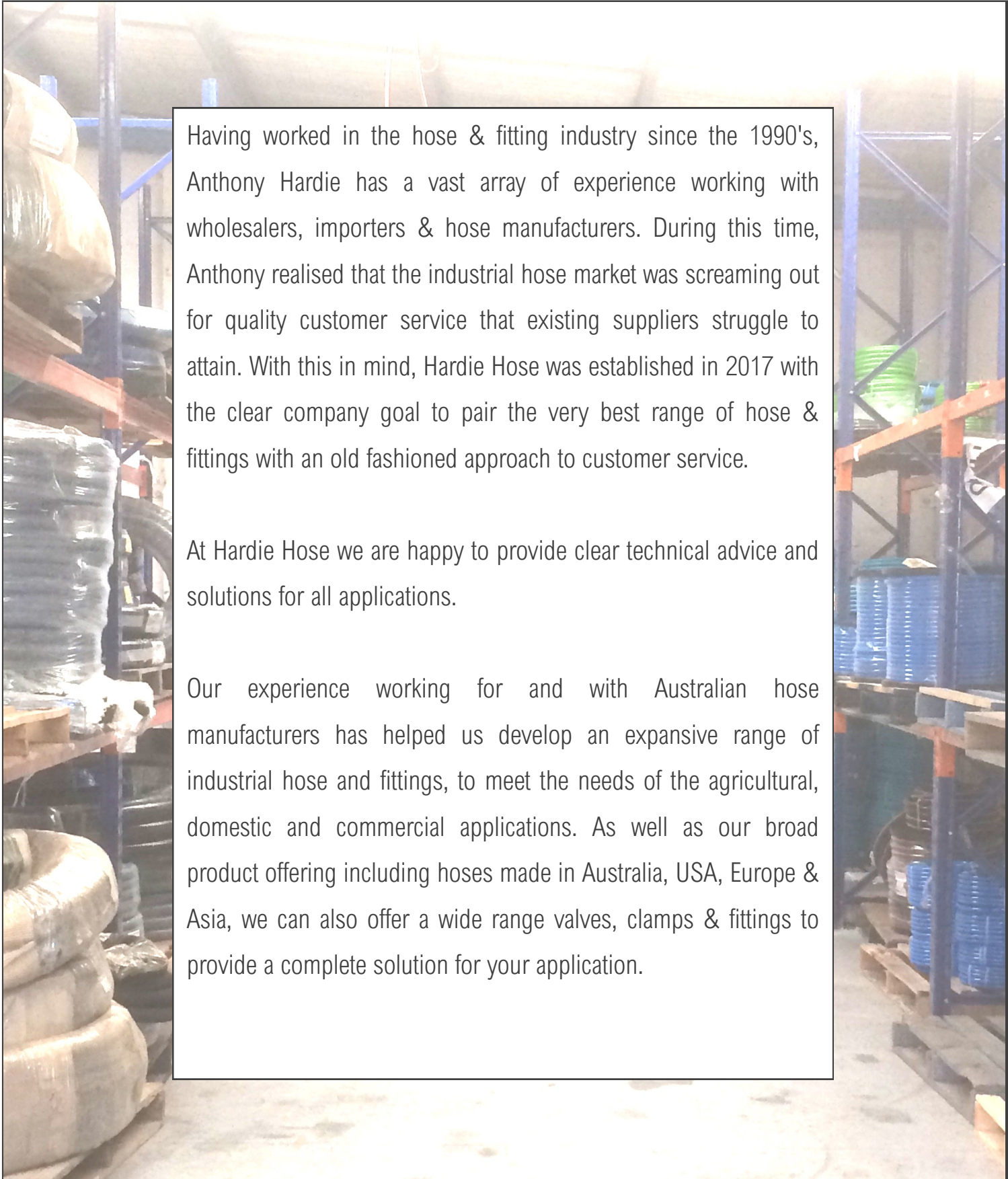

HARDIE HOSE PRODUCT CATALOGUE

VERSION 3 - 2021





Having worked in the hose & fitting industry since the 1990's, Anthony Hardie has a vast array of experience working with wholesalers, importers & hose manufacturers. During this time, Anthony realised that the industrial hose market was screaming out for quality customer service that existing suppliers struggle to attain. With this in mind, Hardie Hose was established in 2017 with the clear company goal to pair the very best range of hose & fittings with an old fashioned approach to customer service.

At Hardie Hose we are happy to provide clear technical advice and solutions for all applications.

Our experience working for and with Australian hose manufacturers has helped us develop an expansive range of industrial hose and fittings, to meet the needs of the agricultural, domestic and commercial applications. As well as our broad product offering including hoses made in Australia, USA, Europe & Asia, we can also offer a wide range valves, clamps & fittings to provide a complete solution for your application.

PVC Hoses	
Suction Hose	1
Delivery Hose	3
Garden Hose & Fittings	7
Layflat Hose	9
Rubber Hose	
Oil	11
Air & Water	12
Washdown & Food Grade	14
Hydraulic	15
Marine	16
Automotive Hose	17
Pinchweld - Rubber & PVC	21
Flexible Ducting	23
Hose Clamps	
HD Lined Clamps, Bolted Claw Clamps & Constant Torque	24
T-Bolt Clamps	25
Wormdrive Clamps	26
Slotted Wormdrives, O-Clips, P Clips & Mini Fuel Clips	27
Bandimex Band, Heavy Duty P Clips	28
Camlocks - Aluminium, Stainless Steel, Polypropylene & Nyglass	29
Flexible Tubing	33
Fittings	
Push-In Fittings - DOT Air Brake & A93 Series Couplings	35
Push-In Fittings - Pneumatic	37
Brass Fittings - Threaded, Hose Tails & Compression	39
Stainless Steel Hose Tails - Industrial & Hygienic (BSM, Triclover, Wine)	42
Stainless Steel Pipe Fittings	44
Poly Fittings & Hose Tails	46
Galvanised Malleable Pipe Fittings	48
Storz, Fire & Bauer Type Fittings	50
Strainers & Nozzles	52
Air Couplings	53
Hydraulic Quick Couplings, Field Attachable Fittings & O-Ring Kits	54
Valves	
Brass Ball & Check Valves	55
Stainless Ball & Check Valves	56
Pressure Gauges	57
Hose Merchandiser Stand	58
Insertion Rubber & Equine Matting	59
Compressed Air Pipe & Fittings	60

PVC SUCTION HOSE

GREY SUCTION

For conveying liquids and light granular materials in agricultural and industrial applications. High quality economical hose for use in irrigation, domestic fire fighting and dewatering. Super flexible product ensuring optimal performance. Conforms to AS/NZS 2070 (plastics for food contact).



I.D. (mm)	O.D. (mm)	PRESSURE (psi)	VACUUM (mm/Hg)	PART #	COIL (m)	CUT
25	32	130	-624	PH-GS025***	20	✓
32	39	105	-624	PH-GS032***	20	✓
38	46	100	-624	PH-GS038***	20 30	✓
50	60	87	-624	PH-GS050***	20 30	✓
63	74	87	-624	PH-GS063***	20	✓
76	88	73	-624	PH-GS075***	20	✓
102	116	58	-624	PH-GS100***	20	✓

CLEAR / WIRE HELIX NON TOXIC

Suitable for applications requiring continuous bending and flexing or where a clear and/or heavy duty hose is required, including food, beverage, cosmetic and pharmaceutical. Can be used for oils and pesticides (boom sprayers). Operating temperature from -10°C to +60°C.

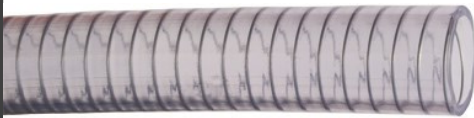

I.D. (mm)	O.D. (mm)	PRESSURE (psi)	VACUUM (mm/Hg)	PART #	COIL (m)	CUT
12	18	85	-625	PH-CS012***	30	✓
19	27	71	-625	PH-CS020***	30	✓
25	33	71	-625	PH-CS025***	30	✓
32	41	57	-625	PH-CS032***	30	✓
38	47	57	-625	PH-CS038***	30	✓
50	60	57	-588	PH-CS050***	30	✓
76	85	51	-515	PH-CS075***	30	✓

BLUE HEAVY DUTY OIL SUCTION

Proudly Australian Made, this heavy duty flexible blue PVC/NBR blend hose with rigid PVC helix is the most flexible suction hose in our range even in colder climates. It has a smooth bore to reduce friction losses and the polymeric plasticizer resists solvent extraction. Operating temperature from -10°C to +60°C. A high nitrile content gives good resistance to abrasion as well as chemicals, animal fats, mineral oils & some fuels. Outstanding UV stability.

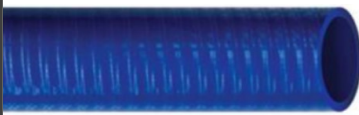

I.D. (mm)	O.D. (mm)	PRESSURE (psi)	VACUUM (mm/Hg)	PART #	COIL (m)	CUT
25	32	130	-624	PH-BS025***	20	✓
32	39	105	-624	PH-BS032***	20	✓
38	46	100	-624	PH-BS038***	20	✓
50	60	87	-624	PH-BS050***	20	✓
63	74	87	-624	PH-BS063***	20	✓
76	88	73	-624	PH-BS076***	20	✓
102	116	58	-624	PH-BS102***	20	✓

WINE SUCTION & DELIVERY HOSE

Suitable for the general purpose suction and discharge of liquids requiring a food grade hose in applications including wineries, canneries, dairies and general food processing plants. Conforms to AS/NZS 2070, USA FDA CFR21 & EU 2002-72-E°C. Suitable for contact with wine and spirits up to 28% ABV. Manufactured from phenol and phthalate free compounds.

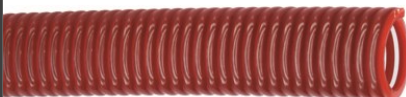

I.D. (mm)	O.D. (mm)	PRESSURE (psi)	VACUUM (mm/Hg)	PART #	COIL (m)	CUT
25	32	130	-624	PH-WS025***	20	✗
32	39	105	-624	PH-WS032***	20	✗
38	46	100	-624	PH-WS038***	20	✗
50	60	87	-624	PH-WS050***	20	✗

Larger sizes on request

PVC SUCTION HOSE



TIGERGRIT

Black inner with corrugated yellow helix. Super flexible abrasion resistant hose suitable for transfer of oils, waste, sand and rocks. Nitrile/PVC blend for excellent flexibility at low temperatures.



I.D. (mm)	O.D. (mm)	COIL (m)	B/R (mm)	PART #	CUT
50	63	20	350	PH-TG050***	✓
63	80	20	380	PH-TG063***	✓
76	93	20	400	PH-TG075***	✓
100	118	20	600	PH-TG100***	✓

BLACK OIL / CHEM

Flexible hose suitable for suction and low pressure delivery of water, mild chemicals and petroleum based products. Typically used on boom sprayers & spray tanks for pesticide transfer. Also suitable for water, chemicals, oils and sillage applications.

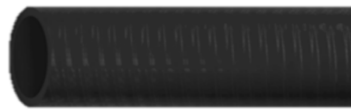

I.D. (mm)	O.D. (mm)	COIL (m)	PART #	CUT
20	26	20	PH-OC020020	✗
25	32	20	PH-OC025020	✗
32	39	20	PH-OC032020	✗
38	46	20	PH-OC038020	✗
50	60	20	PH-OC050020	✗

MARINE SULLAGE

Smooth bore hose well suited to dust extraction, marine, cable protection, LPG conversion, air seeders & caravan waste lines. Raised PVC helix provides excellent flexibility.



I.D. (mm)	O.D. (mm)	COIL (m)	PART #	CUT
20	25	20	PH-MS020020	✓
25	31	20	PH-MS025020	✓
28	35	20	PH-MS028020	✓
32	39	20	PH-MS032020	✓
38	45	20	PH-MS038020	✓
51	57	20	PH-MS050020	✓

CLEAR / BLACK SPIRAL AIRSEEDER

Used as an "air seeder" hose and in other applications where materials being conveyed need to be seen such as pellet and granule transfer.



I.D. (mm)	O.D. (mm)	COIL (m)	PART #	CUT
25	32	20	PH-AS025020	✗
32	39	20	PH-AS032020	✗
38	46	20	PH-AS038020	✗
45	53	20	PH-AS045020	✗
50	60	20	PH-AS050020	✗
63	74	20	PH-AS063020	✗
76	90	20	PH-AS075020	✗

FLEXIBLE SEEDER

Black, super tough air seeder and general purpose hose with superior UV resistance. Corrugated construction provides unmatched flexibility.



I.D. (mm)	O.D. (mm)	COIL (m)	PART #	CUT
20	26	20	PH-FA020020	✗
25	32.5	20	PH-FA025020	✗
28	35.3	20	PH-FA028020	✗
30.5	39.5	20	PH-FA030020	✗
31.5	41	20	PH-FA031020	✗
32	42	20	PH-FA032020	✗
33.5	43.7	20	PH-FA033020	✗
35	45	20	PH-FA035020	✗
38	47.3	20	PH-FA038020	✗
44	53.8	20	PH-FA044020	✗
50	63.3	20	PH-FA050020	✗

INDUSTRIAL AIR HOSE

Blue cover with bright yellow stripe. Australian made hose manufactured from oil resistant compounds. Good weathering properties. Ease of handling in extreme cold conditions and high abrasion resistance for long life. 4:1 safety factor allowing for pressure surges. Meets Australian standard AS 2554 Class B.



I.D. (mm)	O.D. (mm)	PRESSURE (psi)	COIL (m)	PART #	CUT
6	12	230	20, 100,	PH-SU006***	✓
8	14	230	20, 100,	PH-SU008***	✓

DUAL BLUE AIR / CHEMICAL

Australian made, soft blue virgin PVC cover with soft black chemical resistant virgin PVC tube. Suitable for air / water / chemical applications. High tensile synthetic reinforcing with excellent kink resistance and flexibility even at cold temperatures. UV stabilized. Meets AS/NZS 2554 Class B specifications.



I.D. (mm)	O.D. (mm)	PRESSURE (psi)	COIL (m)	PART #	CUT
10	17	300	20 30 40MR 100 300R	PH-CA10****	✓
12	19	300	20 30MR 100 200R	PH-CA12****	✓

HARDIE CLEAR MULTIPURPOSE

The original translucent dual purpose food contact/ petrol hose. Meets AS/NZS 2070, and its distinctive red & gold tracer identifies its dual application.



I.D. (mm)	O.D. (mm)	PRESSURE (psi)	COIL (m)	PART #	CUT
6	12	230	20, 50MR, 100, 300R	PH-CM006***	✓
8	14	230	20, 50MR 100, 300R	PH-CM008***	✓
10	16	230	20, 40MR100, 300R	PH-CM010***	✓
12.5	18	230	20, 30MR, 100, 200R	PH-CM012***	✓
16	22	230	20, 20MR 100	PH-CM016***	✓
20	26	230	20, 100	PH-CM020***	✓
25	33	200	20, 100	PH-CM025***	✓
32	41	145	20	PH-CM032***	✓
38	50	145	20	PH-CM038***	✓
50	62	130	20	PH-CM050***	✓

FIRE REEL HOSE

Black ribbed fire reel hose. Suitable for use on fire hose reels, pumps and for general water transfer.



I.D. (mm)	O.D. (mm)	PRESSURE (psi)	COIL (m)	PART #	CUT
19	26	145	20, 36, 100	PH-FH020***	✗
25	34	145	20, 36, 100	PH-FH025***	✗

PVC DELIVERY HOSE



BLUE STRIPE WASHDOWN HOSE

Made from soft virgin PVC material, this hose is ideally suited for longer life in dairy applications. It has a smooth white cover, white inner tube with blue stripe. This hose has excellent flexibility, kink resistance and a special blend of stabilizers and provides optimum UV protection.



SUITABLE FOR FOOD CONTACT
AS/NZS 2070

I.D. (mm)	O.D. (mm)	PRESSURE (psi)	COIL (m)	PART #	CUT
20	28	145	20, 100	PH-WH020***	✓
25	34.2	145	20, 100, 80MR	PH-WH025***	✓
32	43	145	20, 60, 100	PH-WH032***	✓
38	50	145	20, 60	PH-WH038***	✓

DAIRY BLUE WASHDOWN HOSE

For use in cold water wash down applications. Good flexibility for ease of handling. Tough ribbed cover for improved abrasion resistance. Self-extinguishing.

Custom branding, special colours, lengths and packaging options are available upon request. Working Temperature: 0°C to 50°C.



I.D. (mm)	O.D. (mm)	PRESSURE (psi)	COIL (m)	PART #	CUT
25	34	145	20, 100	PH-DB025***	✗
32	43	145	20, 60	PH-DB032***	✗
38	49	130	20, 60	PH-DB038***	✗

ANTI-STATIC ZERO TEMP DRUM PUMP HOSE

Petrol resistant hose that has a black inner tube and black cover with orange stripe. Hose construction includes two copper anti-static wires. The special compound of the Zero Temp means greater flexibility at cold temperatures while maintaining maximum working performance.



I.D. (mm)	O.D. (mm)	PRESSURE (psi)	COIL (m)	PART #	CUT
25	34	145	20, 85R	PH-ZT025***	✓

DRUM PUMP FARM DELIVERY HOSE

Black with red stripe. Specially formulated inner tube gives drum pump hose a much higher resistance to most common petroleum products. Well suited to low pressure or gravity feed delivery of diesel and kerosene from farm storage tanks.



I.D. (mm)	O.D. (mm)	PRESSURE (psi)	COIL (m)	PART #	CUT
20	28	200	20 100	PH-DP020***	✗
25	33	145	20 100	PH-DP025***	✗
32	42	100	20	PH-DP032***	✗

PVC DELIVERY HOSE

BREATHING AIR HOSE

Also known as diver's or hooker hose. Yellow hose with food grade, non toxic PVC tube. Has excellent kink resistance and can be used for all air breathing applications. Meets AS/NZS 1716 and AS 2299 - 1979.



I.D. (mm)	O.D. (mm)	PRESSURE (psi)	COIL (m)	PART #	CUT
8	14	348	20 100 300R	PH-AB008***	✘
10	18	348	20 100 300R	PH-AB010***	✘

LP GAS HOSE

LP Gas hose for domestic appliances. Suitable for conveying LP Gas. Conforms to AS/NZS 1869 Class A & C.



I.D. (mm)	O.D. (mm)	PRESSURE (psi)	COIL (m)	PART #	CUT
5	12.5	385	20 100	PH-LP005***	✓
6	13	385	20 100	PH-LP006***	✓
8	15	385	20 100	PH-LP008***	✓

DRINKING WATER HOSE (AS 2070/4020)

Specially formulated hose designed to prevent tainting the taste of your water. The hose is made with a blue EVA tube and clear cover, Meets AS 2070 & AS 4020 standards. Suitable for marine, caravan and civil use. Can be used with garden hose 'click-on' fittings.



I.D. (mm)	O.D. (mm)	PRESSURE (psi)	COIL (m)	PART #	CUT
12	17	145	10, 20, 100, 200MR	PH-DW012***	✘
12	17	145	10m Fitted (Garden Hose Fittings)	PH-DW012010F	✘

WHITE HOT WASHDOWN HOSE

All Australian made. Tough, highly abrasion resistant cover. Bright white for high visibility. Good flexibility for ease of handling. UV stabilised for outdoor use. Self extinguishing. Minimum safety factor of 4:1 allowing for pressure surges. Also suitable for washing machines and dishwashers. Working pressure is 200psi @ 20°C. Max temp 80°C.



I.D. (mm)	O.D. (mm)	PRESSURE (psi)	COIL (m)	PART #	CUT
12	19	200	20, 30MR	PH-HW012***	✘
20	28	200	20, 100	PH-HW020***	✘

SAFETY YELLOW AIR / WATER

High quality Air / Water hose with strong durability and excellent flexibility. It's highly visible cover makes it an ideal choice for industrial applications, hard wearing applications. Meets AS/NZS 2554 Class B requirements.



I.D. (mm)	O.D. (mm)	PRESSURE (psi)	COIL (m)	PART #	CUT
20	28	230	20, 100	PH-YL020***	✘
25	35	230	20, 100	PH-YL025***	✘
32	42	230	20, 60	PH-YL032***	✘
38	48	230	20, 60	PH-YL038***	✘
50	62	230	20, 40	PH-YL050***	✘

PVC DELIVERY HOSE



HARDIE HIGH PRESSURE CHEMICAL SPRAY HOSE

This hose is a long established market leader in the agricultural industry.

Hardie High Pressure Chemical Spray hose has a distinctive black cover and yellow inner tube and is a heavy duty, high pressure spray hose suitable for most spraying applications in Australia and New Zealand.

Coils, reels and merchandiser stand available.

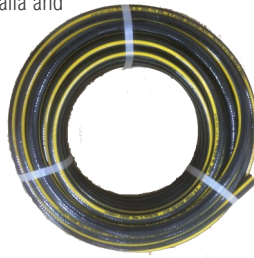

I.D. (mm)	O.D. (mm)	PRESSURE (psi)	COIL (m)	PART #	CUT
8	14	600	20, 60MR, 300R	PH-E6008***	✓
10	17	600	20, 50MR, 100, 300R	PH-E6010***	✓
12.5	20	600	20, 40MR, 100, 200R	PH-E6012***	✓
19	28	300	20, 100R	PH-E3020***	✓
25	35	300	20, 85R	PH-E3025***	✓
32	43	300	20	PH-E3032020	✗
38	49	300	20	PH-E3038020	✗

CLEAR VINYL TUBING

Suitable for food and beverage lines operating at low pressures, general purpose low pressure delivery lines, light syphon lines, cable protection, drainage lines etc. and is petrol resistant.



I.D. (mm)	O.D. (mm)	COIL (m)	PART #	CUT
3	5	30, 200MR	CH-003***	✓
4	6	30, 100MR	CH-004***	✓
5	8	30, 100MR	CH-005***	✓
6	9	30, 100MR	CH-006***	✓
8	11	30, 100MR	CH-008***	✓
10	13	30, 75MR	CH-010***	✓
12.5	16	30, 50MR	CH-012***	✓
16	20	30, 30MR	CH-016***	✓
20	24	30	CH-020***	✓
25	31	30	CH-025***	✓
32	38	15, 30	CH-032***	✓
38	46	10, 30	CH-038***	✓
50	60	10, 15, 30	CH-050***	✓

LIME GREEN DOUBLE BRAID

Superior quality hose for general purpose water applications. Manufactured with all virgin PVC materials this product provides excellent flexibility even at low temperatures. 8 year guarantee. Available in bulk and fitted with plastic tap connections.



I.D. (mm)	O.D. (mm)	PRESSURE (psi)	COIL (m)	PART #	CUT
12.5	17	145	20, 30, 100 ,200MR	GH-DB012***	✘
19	25	145	20, 30, 100MR	GH-DB020***	✘
25	31	130	20, 100	GH-DB025***	✘

HARDIE STAR PREMIUM GARDEN HOSE

Hardie Star Premium is perfect for domestic yards & also commercial use. The hose has excellent kink resistance, a thick inner wall and is UV protected. Premium is Australian made and meets AS 2620-1.



20 YEAR WARRANTY

I.D. (mm)	O.D. (mm)	PRESSURE (psi)	COIL (m)	PART #	CUT
12.5	17	145	20, 30, 100	GH-SP012***	✘
19	25	145	20, 30, 100	GH-SP020***	✘



CLICK-ON FITTINGS - BRASS

SIZE (mm)	DESCRIPTION	PACK	PACKAGING	PART NUMBER
12	HOSE CONNECTOR	1	RETAIL CARD	GR-B12C
12	TAP ADAPTOR	1	RETAIL CARD	GR-B12A
12	4 PIECE SET (WITH NOZZLE)	1	RETAIL CARD	GR-B12SET
12	2 WAY TAP ADAPTOR	1	RETAIL CARD	GR-B2WA
12	4 WAY TAP ADAPTOR	1	RETAIL CARD	GR-B4WA
12	1/2" SPRAY ADAPTER	1	RETAIL CARD	GR-B12M
12	12MM JOINER	1	RETAIL CARD	GR-B12J
18	HOSE CONNECTOR	1	RETAIL CARD	GR-B18C
18	TAP ADAPTOR	1	RETAIL CARD	GR-B18A
18	3/4" SPRAY ADAPTER	1	RETAIL CARD	GR-B18M
18	18MM JOINER	1	RETAIL CARD	GR-B18J



GARDEN FITTINGS



GARDEN HOSE FITTINGS & ACCESSORIES



PART #	ITEM	DESCRIPTION (12mm)	PACK
GR-P12REP	564035	HOSE REPAIRER	12
GR-P12C	564111	HOSE CONNECTOR TAIL	12
GR-P12M	564011B	3/4" BSPM SPRINKLER ADAPTER	20
GR-P12A	564018	3/4"-1" BSPF TAP NUT ADAPTOR	12
GR-P12NOZ	562012	ADJUSTABLE HOSE NUT	12
GR-P12SET	564400	BASIC HOSE SET	10
GR-P12J	564021	2 END COUPLER	20
GR-P12GUN	5652004	TRIGGER GUN	12
GR-P12GUN8F	5633201	8 FUNCTION ZINC TRIGGER GUN	12
PART #	ITEM	DESCRIPTION (18mm)	PACK
GR-P18NOZ	569012	JUMBO NOZZLE	24
GR-P18REP	564036	HOSE REPAIRER	12
GR-P18C	569113	JUMBO HOSE CONNECTOR TAIL	24
GR-P18M	569011	3/4" BSPM JUMBO SPRINKLE ADAPTOR	24
GR-P18A	569018	3/4"-1" BSPF TAP NUT ADAPTOR	24
GR-P18SET	569400	JUMBO HOSE SET	10
GR-P18J	569021	JUMBO 2 END COUPLER	24



SOAKER HOSE

Australian made from UV protected materials. Black in colour providing strong resistance against an aggressive Australian sun. Each hose includes a removable end cap to allow the joining of two or more hoses and flushing through for cleaning. Available in 15 and 30 metre lengths.

SIZE (mm)	COIL (m)	PART #	CUT
12	15	GH-SK015	x
12	30	GH-SK030	x





OROFLEX BANDAMA

Premium quality layflat hose for linear drag irrigation reels.

Also used a heavy duty dredging hose.

Special NBR Rubber compound to resist UV penetration and weathering.

Specially designed extruded hose using nitrile rubber and circular woven polyester/nylon reinforcements provides exceptional kink resistance,

even at low pressures.

Oroflex Bandama has very low elongation properties that eliminates snaking.

Reduced pressure loss is achieved by increase in diameter under pressure.

Fully complies with IA177

10 Year Pro-rata warranty.

DIAMETER	Inch	2 1/2	3	3 1/2	4	4 1/8	4 1/2	5	6
	mm	63	76	90	102	105	114	127	152
Working pressure	bar.	15,5	14	14	14	12	12	10	10
Burst pressure	bar.	50	40	40	40	35	35	30	30
Weight	g/m	850	900	1,150	1,400	1,450	1,600	1,800	2,200
Thickness	mm	2,8	3,1	3,4	3,6	3,6	3,7	3,8	3,8
Tensile Strength*	kg	5.320	8.380	9.300	10.000	10.000	11.500	12.320	15.000
Bend Radius	mm	1,200	1,300	1,300	1,500	1,500	1,550	1,700	1,750

* Total theoretical Tensile Strength. End Pull at working conditions should not pass 1/3 of this value.

APPLICATIONS

- Irrigation travelers (drag irrigators)
- Linear move supply line
- Flexible pipeline
- Slurry, sludge and liquid manure pumping
- Heavy duty dredge discharge
- Applications where high resistance to abrasion is required

LAYFLAT HOSE



BLUE PVC LOW PRESSURE

The blue low pressure layflat has a one layer construction which means it can be pierced without causing delamination. Suitable for low pressure transfer and trickle irrigation applications, it is also suitable for light duty dewatering applications.



I.D. (mm)	PRESSURE (psi)	COIL (m)	PART #	CUT
25	75	100	PL-BL025100	✓
32	75	100	PL-BL032100	✓
38	75	25, 100	PL-BL038***	✓
51	65	25, 50, 100	PL-BL050***	✓
63	60	100	PL-BL063100	✓
76	50	50, 100	PL-BL075***	✓
102	45	50, 100	PL-BL100***	✓
152	45	100	PL-BL150100	✗
203	45	100	PL-BL200100	✗

RED PVC "SUNNY" HEAVY DUTY

Excellent abrasion resistance allowing it to be used in heavy duty dewatering application, where water may be mixed with solid particles. Also used on small irrigators.



I.D. (mm)	PRESSURE (psi)	COIL (m)	PART #	CUT
38	152	100	PL-RD038100	✓
51	152	100	PL-RD050100	✓
63	152	100	PL-RD063100	✓
76	130	100	PL-RD075100	✓
102	130	100	PL-RD100100	✓
152	102	100	PL-RD150100	✗
203	75	100	PL-RD200100	✗

FIRE HOSE

Canvas style non-percolating layflat hose. Suitable for rural fire fighting and general water transfer applications.



I.D. (mm)	PRESSURE (psi)	COIL (m)	PART #	CUT
25	220	30	PL-FH025030	✗
38	220	30	PL-FH038030	✗
50	220	30	PL-FH050030	✗
64	220	30	PL-FH063030	✗
76	220	30	PL-FH075030	✗
102	220	30	PL-FH100030	✗

BLUE PVC LAYFLAT ASSEMBLIES

Boxed assembly of 50mm x 20m blue layflat hose complete with male & female aluminium camlocks.

I.D. (mm)	PRESSURE (psi)	COIL (m)	PART #
50	65	20	PL-BL050020CE



OROFLEX 20

Premium rubber layflat. The integrated tube and cover offers excellent abrasion resistance, minimal friction losses and UV resistance. Black Nitrile tube and cover, high strength circular woven textile braid, temp range -30 to +70°C.

I.D ranging from 65 to 150 mm.



HARDIEFLEX PREMIUM OIL S&D

Premium highly flexible hose suitable for suction and delivery of a wide range of petroleum products up to a 50% aromatic content. Black nitrile tube and cover, synthetic ply reinforcement, temp range -15 to +70°C.



I.D. (mm)	O.D. (mm)	PRESSURE (psi)	BEND RAD. (mm)	WEIGHT (kg/m)	COIL (m)	PART #	CUT
20	29	150	65	0.57	20	RH-OSH020***	✓
22	32	150	75	0.62	20	RH-OSH022***	✓
25	36	150	90	0.68	20	RH-OSH025***	✓
32	43	150	115	0.82	20	RH-OSH032***	✓
35	46	150	125	0.89	20	RH-OSH035***	✓
38	49	150	135	0.96	20	RH-OSH038***	✓
45	57	150	160	1.32	20	RH-OSH045***	✓
50	62	150	185	1.69	20	RH-OSH050***	✓

OIL DELIVERY

Delivery of a wide range of petroleum products up to a 50% aromatic content. Black Nitrile tube and cover, synthetic ply reinforcement, temp range -15 to +70°C.



I.D. (mm)	O.D. (mm)	PRESSURE (psi)	COIL (m)	PART #	CUT
20	29	150	20	RH-OD020***	✓
25	35	150	20	RH-OD025***	✓
32	42	150	20	RH-OD032***	✓
38	48	150	20	RH-OD038***	✓
45	55	150	20	RH-OD045***	✓
51	62	150	20	RH-OD050***	✓

OIL SUCTION & DELIVERY

Oil hose for use with hydraulic systems as an oil return hose or various petroleum products. Black nitrile tube and cover, synthetic ply reinforcement incorporating steel helix. Suitable for petroleum products up to 50% aromatic content. Temp range -20 to +75°C



I.D. (mm)	O.D. (mm)	PRESSURE (psi)	COIL (m)	PART #	CUT
25	36	150	20	RH-OS025***	✓
32	43	150	20	RH-OS032***	✓
38	49	150	20	RH-OS038***	✓
51	63	150	20	RH-OS050***	✓
63	77	150	20	RH-OS063***	✓
76	89	150	20	RH-OS075***	✓

HARDIE R6 MULTIPURPOSE

SAE100R6 premium multipurpose hose for use in air, water, oil and many chemical applications. Black nitrile inner tube, textile reinforcement and red neoprene cover. Temp range -29 to +95°C.



I.D. (mm)	O.D. (mm)	PRESSURE (psi)	COIL (m)	REEL (m)	PART #	CUT
5	12	300	20	200	RH-MP005MTR	✓
6	13	400	30	150	RH-MP006MTR	✓
8	15	400	30	150	RH-MP008MTR	✓
10	17	400	30	150	RH-MP010MTR	✓
12	21	400	20	100	RH-MP012MTR	✓
16	26	300	20	100	RH-MP016MTR	✓
20	29	300	20	100	RH-MP020MTR	✓
25	36	300	20	70	RH-MP025MTR	✓
32	44	150	20		RH-MP032MTR	✓
38	54	150	20		RH-MP038MTR	✓

RUBBER HOSE



WATER DELIVERY

Water delivery hose suitable for medium duty water delivery requirements in general industrial and civil applications. Black SBR tube and cover, synthetic ply reinforcement.

Temperature range -40 to +85°C.



I.D. (mm)	O.D. (mm)	PRESSURE (psi)	COIL (m)	PART #	CUT
20	28	150	20	RH-WD020***	✓
25	33	150	20	RH-WD025***	✓
32	42	150	20	RH-WD032***	✓
38	48	150	20	RH-WD038***	✓
50	61	150	20	RH-WD050***	✓
63	75	150	20	RH-WD063***	✓
75	88	150	20	RH-WD075***	✓
100	114	150	20	RH-WD100***	✓

HEAVY DUTY AIR & WATER DELIVERY

Heavy Duty air & water hose suitable for civil, industrial and mining use. Black SBR tube and cover, synthetic ply reinforcement.

Temperature range -40 to +85°C.



I.D. (mm)	O.D. (mm)	PRESSURE (psi)	COIL (m)	PART #	CUT
20	29	300	20	RH-AW3020***	✓
25	36	300	20	RH-AW3025***	✓
32	44	300	20	RH-AW3032***	✓
38	50	300	20	RH-AW3038***	✓
50	63	300	20	RH-AW3050***	✓

WATER SUCTION & DELIVERY

Water suction and delivery Hose for full suction and high discharge pressures. Black SBR cover with green stripe, black SBR tube, synthetic ply reinforcement with steel helix.

Temperature range -40 to +85°C.

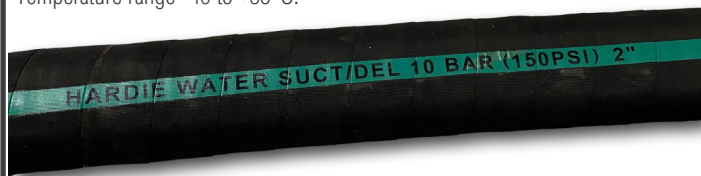

I.D. (mm)	O.D. (mm)	PRESSURE (psi)	COIL (m)	PART #	CUT
25	36	150	20	RH-WS025***	✓
32	43	150	20	RH-WS032***	✓
38	49	150	20	RH-WS038***	✓
50	62	150	20	RH-WS050***	✓
63	76	150	20	RH-WS063***	✓
76	89	150	20	RH-WS075***	✓
100	116	150	20	RH-WS100***	✓
125	143	150	20	RH-WS125***	✓
150	168	150	20	RH-WS150***	✓

GENERAL PURPOSE AIR & WATER

General purpose black air and water delivery hose that is suitable for many agricultural chemicals. Smooth black EPDM tube and cover, synthetic ply reinforcement, temperature range -40 to +100°C.



I.D. (mm)	O.D. (mm)	PRESSURE (psi)	REEL (m)	PART #	CUT
6	13	200	183	RH-AW006MTR	✘
10	17	200	183	RH-AW010MTR	✓
12	21	200	183	RH-AW012MTR	✓
16	25	200	183	RH-AW016MTR	✘
20	28	200	183	RH-AW020MTR	✓
25	36	200	107	RH-AW025MTR	✓

YELLOW PNEUMATIC JACKHAMMER HOSE

Economical air & water hose. It is suitable for industrial, construction and agricultural applications. Black SBR tube and yellow cover, synthetic ply reinforcement, temp range 0 to +70°C.

Assemblies also available fitted with Type A Claw Couplings.



I.D. (mm)	O.D. (mm)	PRESSURE (psi)	COIL (m)	PART #	CUT
19	29	300	20	RH-YA020020	✗
25	37	300	20	RH-YA025020	✗
19	29	300	20 Type A Fitted	RH-YA020020F	✗
25	37	300	20 Type A Fitted	RH-YA025020F	✗

PUSH LOCK HOSE

Multipurpose oil resistant hose suitable for use with air, water, mild chemicals and various petroleum products. Lightweight and flexible. Tube and cover are RMA (Class A) high oil resistant with synthetic ply reinforcement.

Temp range -40 to +100°C.

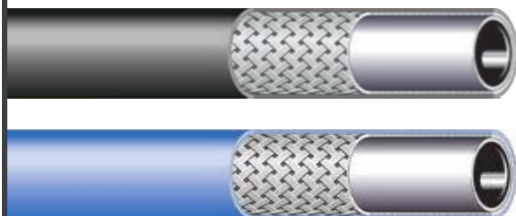

I.D. (mm)	O.D. (mm)	PRESSURE (psi)	REEL (m)	COVER COLOUR	PART #	CUT
10	16	300	91	Black	RH-PL010BK	✓
12	20	300	91	Black	RH-PL012BK	✓
10	16	300	91	Blue	RH-PL010BL	✓
12	20	300	91	Blue	RH-PL012BL	✓

FRAS AIR & WATER DELIVERY HOSE

Heavy duty, fire resistant anti-static hose for use with air, water & stone dust delivery specifically in underground mining applications. Black conductive SBR/NR tube, black conductive SBR cover. Abrasion, ozone and fire resistant. Temperature range -30 to +80°C.



I.D. (mm)	O.D. (mm)	PRESSURE (psi)	COIL (m)	PART #	CUT
19	31	300	20	RH-FR020020	✗
25	37	300	20	RH-FR025020	✗
32	46	300	20	RH-FR032020	✗
38	52	300	20	RH-FR038020	✗
50	67	300	20	RH-FR050020	✗

RUBBER HOSE



BLUE FDA WASHDOWN HOSE

FDA approved hose designed for floor and equipment washdown in dairies, creameries, food processing plants and paper mills. White EPDM tube with blue cover, high tensile synthetic yarn reinforcement. Temp range -30 to +120°C. Phthalate free.

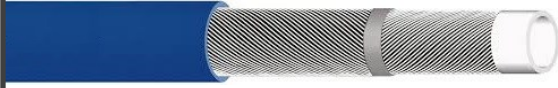

I.D. (mm)	O.D. (mm)	PRESSURE (psi)	COIL (m)	PART #	CUT
13	22	200	100	RH-HW012MTR	✓
19	31	200	60	RH-HW020MTR	✓
25	37	200	60	RH-HW025MTR	✓

FOOD SUCTION & DELIVERY HOSE

Super flexible suction & delivery hose suitable for conveying liquid and fatty foods as well as alcoholic beverages and potable water. Tube compliant to FDA, Italian D.M. 21/03/73 & 3A Class II in accordance with EC 1935/2004 & EC 2023/2006.

Totally phthalate & BPA (Bisphenol A) free. Temp -30 to +110°C.

Assemblies available - see page 43 for our hygienic fitting range.



I.D. (mm)	O.D. (mm)	PRESSURE (psi)	COIL (m)	PART #	CUT
25	36	150	30.5	RH-FS025MTR	✓
32	43	150	30.5	RH-FS032MTR	✓
38	49	150	30.5	RH-FS038MTR	✓
50	63	150	30.5	RH-FS050MTR	✓
63	76	150	30.5	RH-FS063MTR	✓
75	89	150	30.5	RH-FS075MTR	✓
100	116	150	30.5	RH-FS100MTR	✓

HARDIEJET PRESSURE WASHER HOSE

Smooth, blue non marking hose for use on carpet cleaning and pressure washer machines. Tube: water, hot water & detergent solution resistant special synthetic rubber. Cover: Oil, abrasion and weather resistant special synthetic rubber.

Temperature range -40 to +150°C.

Fitted assemblies available.



I.D. (mm)	O.D. (mm)	REEL (m)	PRESSURE (psi)	PART #	CUT
6	13	150	3060	HH-PW1-006	✓
10	17	150	5800	HH-PW2-010	✓

STEEL STEAM

Black conductive EPDM inner tube, resistant to saturated steam. High tensile steel wire reinforcement. Red pin pricked EPDM cover with excellent resistance to abrasion, heat, steam, ozone and weather. 10:1 Safety factor.

Temperature range: -40 to + 210°C (intermittent to 232°C)



I.D. (mm)	O.D. (mm)	WORKING PRESSURE (psi)	BURST PRESSURE (psi)	COIL (m)	PART #	CUT
12	24	247	2465	20	RH-ST012***	✓
19	32	247	2465	20	RH-ST019***	✓
25	38	247	2465	20	RH-ST025***	✓

RUBBER HOSE

HYDRAULIC HOSE - SAE 100R2AT

Hardie smooth cover two-wire hydraulic hose is suitable for use with petroleum based hydraulic fluids in hydraulic systems on various agricultural, construction and industrial equipment. Oil resistant synthetic rubber inner tube with oil, weather and abrasion resistant synthetic rubber cover. Meets SAE 100R2AT specifications.

Temperature range -40 to +100°C

Fitted assemblies available.



I.D. (mm)	O.D. (mm)	REEL (m)	PRESSURE (psi)	PART #	CUT
6	16	100	5075	HH-2W-04	✓
10	19	100	4060	HH-2W-06	✓
12	23	100	3550	HH-2W-08	✓
20	30	50	2280	HH-2W-12	✓
25	39	50	2030	HH-2W-16	✓

PLASTIC SPIRAL GUARD

Spiral guard is a light weight and cost effective method of protecting hoses and cables from abrasion and impact. Due to the flexible and expanding nature of PSG it is possible to wrap individual hoses as well as bundles of hoses in a loom. The product has been designed with a rounded profile for ease of fitment and no sharp edges means no chance of cutting the hose. Available in black only.



HOSE O.D. (min)	HOSE O.D. (max)	CARTON (m)	PART #	CUT
9	13	20	HH-SG012	✗
12	17	20	HH-SG016	✗
16	22	20	HH-SG020	✗
21	28	20	HH-SG025	✗
27	33	20	HH-SG032	✗
32	42	20	HH-SG040	✗
41	53	20	HH-SG050	✗
52	65	20	HH-SG063	✗
64	80	20	HH-SG075	✗
79	150	10	HH-SG090	✗
150+		10	HH-SG110	✗

HOSE BEND RESTRICTORS

Vinyl hose bend restrictors prolong the life of hose assemblies by preventing excessive strain on the hose at the fitting.

Especially suitable for pressure washer hoses, they also help protect the operator in the event of hose failure at the fitting.

HFM-SR04 Suits 1/4in hose (HH-PW1-006 & similar)

HFM-SR06 Suits 3/8in hose (HH-PW2-010 & similar)



RUBBER HOSE



MARINE FUEL LINE

Mandrel built hose for delivery of petrol, diesel oil and biodiesel to engines on private boats up to 24m. Special composition allows smaller than standard outer diameter whilst maintaining kink and permeation resistance. Meets ISO 7840:2013 A1 and SAE J 1527:2011 USCG A1. RINA & Lloyd's Approved.



I.D. (mm)	O.D. (mm)	PRESSURE (psi)	COIL (m)	PART #	CUT
6	15	200	40	RH-MF006MTR	✓
8	16	200	40	RH-MF008MTR	✓
10	18	200	40	RH-MF010MTR	✓
12	21	145	40	RH-MF012MTR	✓
16	25	145	40	RH-MF016MTR	✓

MARINE FUEL FILLER

Mandrel built hose for delivery of petrol, diesel oil and biodiesel to tanks and engines on private boats up to 24m. Special composition allows smaller than standard outer diameter whilst maintaining kink and permeation resistance. Meets ISO 7840:2013 A1 and SAE J 1527:2011 USCG A1. RINA & Lloyd's Approved.



I.D. (mm)	O.D. (mm)	PRESSURE (psi)	B/RADIUS (mm)	COIL (m)	PART #	CUT
38	47	150	60	20	RH-FF038MTR	✓
50	62	150	75	20	RH-FF050MTR	✓



MARINE EXHAUST

Marine exhaust hose suitable also for cooling heat exchangers on pleasure boats. According to SAE J 2006:13 R2 - ISO 13363:2016 Type 2 Class B. With homologation Lloyd's Register - RINA.

Temp range -30 to +100°C.



I.D. (mm)	PRESSURE (psi)	B/RADIUS (mm)	WEIGHT (kg/m)	COIL (m)	PART #	CUT
38	45	80	0.76	20	RH-ME038***	✓
45	45	90	0.89	20	RH-ME044***	✓
50	45	100	0.99	20	RH-ME050***	✓
57	45	115	1.23	20	RH-ME057***	✓
60	45	120	1.28	20	RH-ME060***	✓
63	45	125	1.65	20	RH-ME063***	✓
75	45	150	1.97	20	RH-ME076***	✓
90	45	180	2.51	20	RH-ME088***	✓
100	45	200	2.79	20	RH-ME100***	✓
125	45	250	3.36	20	RH-ME125***	✓
150	45	300	4.70	20	RH-ME150***	✓

BULK MATERIAL HANDLING

Lightweight and flexible mandrel built hose for suction and delivery of bulk materials such as cement, chalk, lime and other abrasive powders. Black, smooth conductive rubber tube, high tensile textile plies & embedded wire helix, corrugated abrasion resistant cover. Temperature range -35 to +70°C.

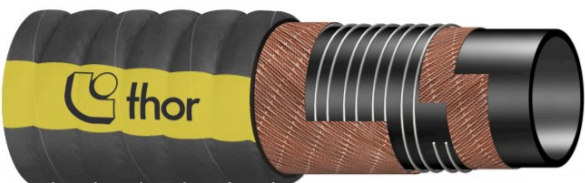

I.D. (mm)	TUBE (mm)	PRESSURE (psi)	COIL (m)	PART #	CUT
76	2	45	30	RH-MH075MTR	✓
102	3	45	30	RH-MH100MTR	✓
127	3	45	30	RH-MH125MTR	✓
152	3	45	30	RH-MH150MTR	✓
203	3	45	30	RH-MH200MTR	✓

AUTOMOTIVE HOSE

FUEL HOSE - SAE 30R6

Codan fuel hose is designed to carry automotive fuel and operates at temperatures ranging from -30°C to +100°C. The inner tube is made from NBR (Nitrile) with an outer cover of CR (Neoprene). This hose is suitable for unleaded petrol (up to 98 octane) and diesel, it is not suitable for ethanol blends of petrol or biodiesel.



I.D. (mm)	WALL THICKNESS (mm)	O.D. (mm)	PRESSURE (psi)	BEND RADIUS (mm)	COIL (m)	PART #	CUT
4.8	3	10.8	50	15	7, 30	AH-FL005***	✓
6.3	3.2	12.7	50	20	7, 25, 100	AH-FL006***	✓
7.9	3.4	14.7	50	25	7, 25, 100	AH-FL008***	✓
9.5	3.6	16.7	50	40	7, 25, 100	AH-FL010***	✓
12.7	3.8	20.3	35	50	7, 30	AH-FL012***	✓

SUBMERSIBLE FUEL HOSE - SAE 30R10

Codan R10 Submersible Fuel Hose is specifically designed for in-tank applications where the hose is in constant contact with fuel and other liquid petroleum fuels. This hose is suitable to handle fuel, alcohol-extended fuel or diesel on the inside and the outside when fully immersed, mobile or stationary for both automotive and marine applications.



I.D. (mm)	WALL THICKNESS (mm)	O.D. (mm)	PRESSURE (psi)	BEND RADIUS (mm)	COIL (mm)	PART #	CUT
7.9	3.0	14.0	100	25	300	AH-SFH008300	✗

FUEL INJECTION HOSE - SAE 30R9

Codan R9 EFI Hose is designed to run a higher pressures and temperatures than normal Fuel Injection Hoses. The inner liner is made of FKM (Viton), the inner tube from NBR (Nitrile) with an outer cover of CSM (Hypalon). This hose is suitable for petrol with a maximum E20 rating and diesel with a maximum B10 rating, it is not suitable for fuels above E20 or B10. This hose is not submersible for in tank use.



I.D. (mm)	WALL THICKNESS (mm)	O.D. (mm)	PRESSURE (psi)	BEND RADIUS (mm)	COIL (m)	PART #	CUT
6.3	3.1	12.4	100	20	7	AH-EFI006***	✗
7.9	3.1	14.0	100	25	7	AH-EFI008***	✓
9.5	3.2	15.8	100	40	7	AH-EFI010***	✗

AUTOMOTIVE HOSE STAND

Merchandise stand of 12 common automotive hoses covering fuel, transmission, vacuum/washer and brake vacuum in fast moving sizes.

	SIZES (mm)	LENGTH (m)
Fuel Hose (R6)	4.8 6.3 7.9 9.5	7
Fuel Injection (R9)	7.9	7
Transmission Cooler	7.9	7
Vacuum & Washer	2.5 3.0 4.0 5.5 6.3	15
Brake Vacuum Hose	9.5	7



AUTOMOTIVE HOSE



HEATER HOSE

Codan Heater Hose has been specifically developed for vehicle coolant systems and has a safety factor of 3:1. It is suitable for use over a temperature range of -40°C to +100°C. It is not suitable for use with petroleum products.



I.D. (mm)	WALL THICKNESS (mm)	O.D. (mm)	PRESSURE (psi)	BEND RADIUS (mm)	COIL (m)	PART #	CUT
5	3.2	11.5	145	30	30	AH-CH005030	✘
8	3.0	140	145	40	30	AH-CH008030	✘
9.5	3.75	17.0	145	50	25, 50, 100	AH-CH010***	✘
12.7	3.4	19.5	145	50	15, 50, 100	AH-CH012***	✓
16	3.4	22.8	145	80	15, 50, 100	AH-CH016***	✓
19	3.6	26.3	145	100	15, 50	AH-CH020***	✘

TRANSMISSION COOLER HOSE

Codan Transmission Cooler Hose is suitable for use with modern automatic transmissions. It is manufactured with a nitrile inner, reinforced with polyester and covered by a neoprene outer that is resistant to oil, fuel and heat. It can withstand temperatures ranging from -40°C to +135°C.



I.D. (mm)	WALL THICKNESS (mm)	O.D. (mm)	PRESSURE (psi)	BEND RADIUS (mm)	COIL (m)	PART #	CUT
7.9	3.4	14.7	50	25	7	AH-TC008***	✓
9.5	3.6	16.7	50	40	7	AH-TC010***	✘

VACUUM AND WASHER TUBING

Codan Vacuum and Washer Tubing is designed for use in windscreen washer systems and vacuum operated controls. It is manufactured from EPDM rubber and will withstand the pressure exerted by windscreen washer systems and control system vacuum. It is heat and weather resistant.

I.D. (mm)	WALL THICKNESS (mm)	O.D. (mm)	COIL (m)	PART #	CUT
2.5	2	6.5	15	AH-WWT002015	✓
3	2	7	15	AH-WWT003015	✓
4	2	8	15	AH-WWT004015	✓
5.5	2	10	15	AH-WWT005015	✓
6.3	2	10.5	15	AH-WWT006015	✓

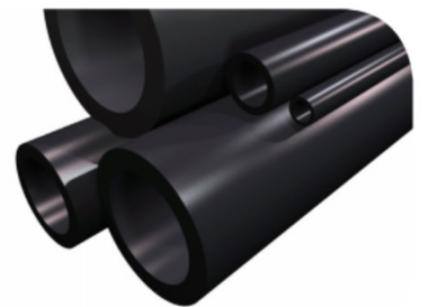

RADIATOR OVERFLOW HOSE

Codan Radiator Overflow Hose Tubing is suitable for radiator overflow and header tank applications. It is manufactured from EPDM rubber and will withstand radiator temperatures and pressures as well as vacuum. It is weather and radiator additive resistant.

I.D.	WALL THICKNESS	O.D.	COIL	PART #	CUT
8	2	12	15	AH-WWT008015	✘
10	2	14	15	AH-WWT010015	✘

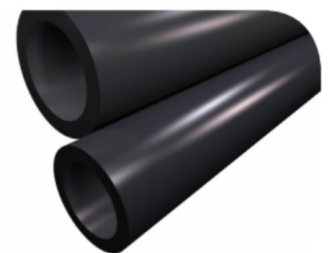

LPG VAPOUR HOSE

Codan Vapour Hose is specifically designed to carry vapours from automotive LPG conversions. This hose is manufactured from neoprene based tube and is encased in a braided cotton outer reinforcement. It is oil and petrol resistant.



I.D. (mm)	WALL THICKNESS (mm)	O.D. (mm)	WORKING PRESSURE (psi)	BEND RADIUS (mm)	COIL (m)	PART #	CUT
12	3.2	18.4	290	60	20	AH-LPV012020	✘
17	3.5	23.4	290	80	20	AH-LPV017020	✘
19	3.5	26.0	290	90	20	AH-LPV019020	✘
25	4.5	34.0	290	100	20	AH-LPV025020	✘

BRAKE VACUUM HOSE

Codan Brake Vacuum Hose is designed to transmit manifold vacuum in automotive power assisted braking systems. It is manufactured from neoprene and reinforced with rayon.



I.D. (mm)	WALL THICKNESS (mm)	O.D. (mm)	VACUUM TESTED TO (%)	BEND RADIUS (mm)	COIL (m)	PART #	CUT
8.7	4	17.5	87	30	7, 30	AH-BVA09***	✓
12.5	4	20	87	30	7, 30	AH-BVA12***	✘

POWER STEERING RETURN HOSE

Codan Power Steering Hose is specifically designed as low pressure side return hose for vehicle powered steering systems. It is manufactured with nitrile inner, reinforced with polyester and covered by a neoprene outer that is resistant to oil, fuel and heat.



I.D. (mm)	WALL THICKNESS (mm)	O.D. (mm)	WORKING PRESSURE (psi)	BEND RADIUS (mm)	COIL (m)	PART #	CUT
7.9	4	16	250	25	7, 30	AH-PSH008***	✘
10	4	16	250	40	7, 30	AH-PSH010***	✘

UNIVERSAL HOSE BEND

These 90 Degree Universal Hose Bends are available in popular sizes to suit most water and coolant applications. Manufactured to Codan's high standards, these hose bends are suitable for an array of automotive and industrial uses.

I.D. (mm)	LENGTH A (mm)	PART NUMBER	CUT
9.45	190	AH-WH90-09	✘
12.7	190	AH-WH90-13	✘
15.9	190	AH-WH90-16	✘
19.05	190	AH-WH90-19	✘
22.25	190	AH-WH90-22	✘
25.4	190	AH-WH90-25	✘
31.8	190	AH-WH90-32	✘
34.95	190	AH-WH90-35	✘
38.1	190	AH-WH90-38	✘

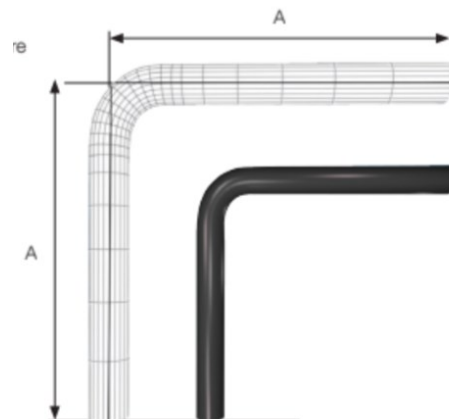

AUTOMOTIVE HOSE



STRAIGHT RADIATOR HOSE

SAE J20R1 standard straight radiator hose is ideal for straight coolant/air connection in automotive, stationary engine, industrial and home applications. EPDM tube and cover with synthetic ply reinforcement.



I.D. (mm)	PRESSURE (psi)	PART #
19	57	AH-SR019
22	57	AH-SR022
25	57	AH-SR025
29	57	AH-SR029
32	57	AH-SR032
35	57	AH-SR035
38	57	AH-SR038
41	57	AH-SR041
44	57	AH-SR044
48	57	AH-SR048
51	57	AH-SR051

I.D. (mm)	PRESSURE (psi)	PART #
54	57	AH-SR054
57	57	AH-SR057
60	57	AH-SR060
63	57	AH-SR063
67	57	AH-SR067
70	57	AH-SR070
73	57	AH-SR073
76	57	AH-SR076
80	57	AH-SR080
89	57	AH-SR089
102	57	AH-SR102

SILICONE RADIATOR HOSE

Exceeds SAE J20R1. Excellent for extreme ambient and radiant temperature conditions. Resists weathering, ozone, heat and coolant deterioration. For use in radiator, heater and other coolant transfer hose applications. 1000mm lengths. Temperature range -53 to +176°C.



I.D. (mm)	PRESSURE (psi)	PART #
19	108	AH-SC019
22	108	AH-SC022
25	100	AH-SC025
28	100	AH-SC028
32	92	AH-SC032
35	92	AH-SC035
38	83	AH-SC038
44	75	AH-SC044

I.D. (mm)	PRESSURE (psi)	PART #
50	66	AH-SC050
57	58	AH-SC057
63	50	AH-SC063
70	42	AH-SC070
76	29	AH-SC076
89	25	AH-SC089
102	16	AH-SC102

SILICONE HEATER HOSE

Exceeds SAE J20R3. Ideal for extreme temperature and hostile engine environments where high performance is required. Temperature range -53 to +176°C.



I.D. (mm)	PRESSURE (psi)	PART #
6	83	AH-SH006
8	83	AH-SH008
10	83	AH-SH010
12	83	AH-SH012
16	83	AH-SH016
20	66	AH-SH020
22	58	AH-SH022
25	58	AH-SH025

EPDM RUBBER & SPONGE

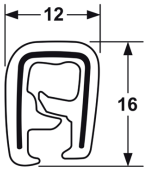
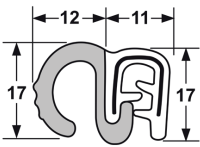
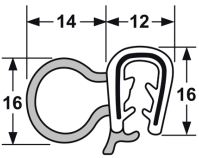
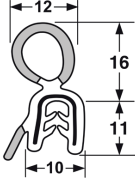
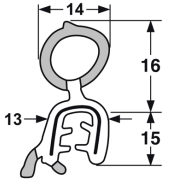
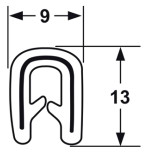
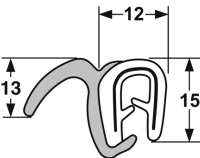
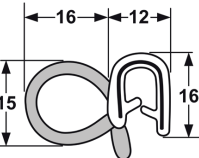
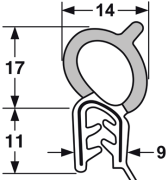
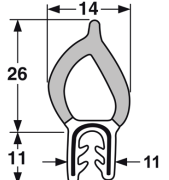
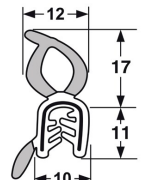
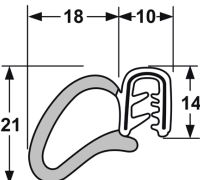
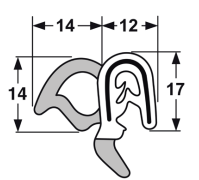
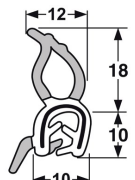
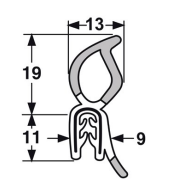
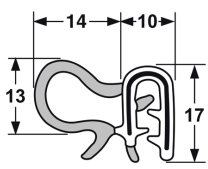
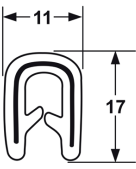
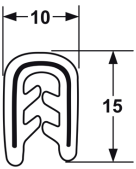
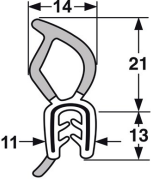
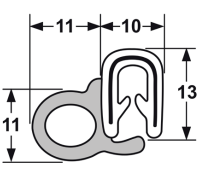
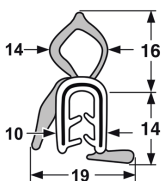
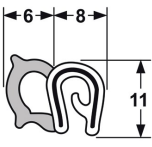
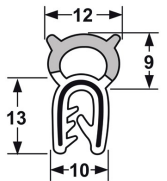
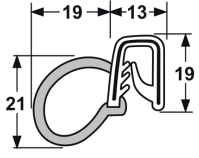
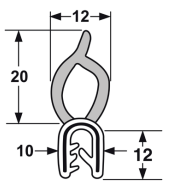
 <p>Grip Range: 1.0 - 4.0 mm</p>	 <p>Grip Range: 1.0 - 4.0 mm</p>	 <p>Grip Range: 1.0 - 4.0 mm</p>	 <p>Grip Range: 1.0 - 2.5 mm</p>	 <p>Grip Range: 1.0 - 3.0 mm</p>
PW-66-002	PW-66-003	PW-66-004	PW-66-005	PW-66-006
 <p>Grip Range: 1.0 - 3.0 mm</p>	 <p>Grip Range: 1.0 - 3.0 mm</p>	 <p>Grip Range: 1.0 - 3.0 mm</p>	 <p>Grip Range: 1.0 - 3.0 mm</p>	 <p>Grip Range: 1.0 - 2.5 mm</p>
PW-66-007	PW-66-008	PW-66-009	PW-66-010	PW-66-011
 <p>Grip Range: 1.0 - 2.5 mm</p>	 <p>Grip Range: 1.0 - 3.0 mm</p>	 <p>Grip Range: 1.0 - 3.0 mm</p>	 <p>Grip Range: 1.0 - 3.0 mm</p>	 <p>Grip Range: 1.0 - 2.0 mm</p>
PW-66-012	PW-66-013	PW-66-014	PW-66-015	PW-66-016
 <p>Grip Range: 1.0 - 4.0 mm</p>	 <p>Grip Range: 1.0 - 4.0 mm</p>	 <p>Grip Range: 1.0 - 4.0 mm</p>	 <p>Grip Range: 1.0 - 4.0 mm</p>	 <p>Grip Range: 1.0 - 2.5 mm</p>
PW-66-017	PW-66-018	PW-66-020	PW-66-022	PW-66-040
 <p>Grip Range: 1.0 - 4.0 mm</p>	 <p>Grip Range: 1.0 - 2.5 mm</p>	 <p>Grip Range: 1.0 - 2.5 mm</p>	 <p>Grip Range: 2.0 - 5.0 mm</p>	 <p>Grip Range: 1.0 - 3.0 mm</p>
PW-66-052	PW-66-056	PW-66-057	PW-66-060	PW-66-115

The materials listed above have been tested to comply with the requirements of FMVSS302. Submitted samples shall not burn, nor transmit a flame front across its surface at a rate of more than 102mm per minute. All dimensions listed are mm. Stock coil length is 50m.

EPDM RUBBER & SPONGE

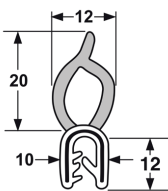
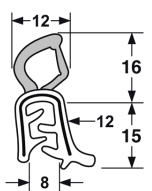
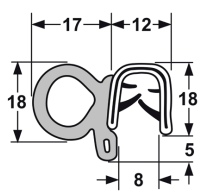
 <p>Grip Range: 1.0 - 3.0 mm</p> <p>PW-66-115</p>	 <p>Grip Range: 1.0 - 3.0 mm</p> <p>PW-66-137</p>	 <p>Grip Range: 1.5 - 5.0 mm</p> <p>PW-66-157</p>		
--	--	--	--	--

EPDM RUBBER & SPONGE - SCHLEGEL CAGE (SUPER FLEXIBLE)

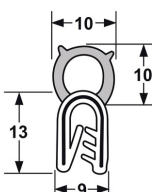
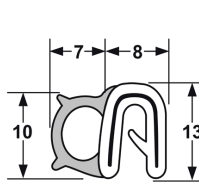
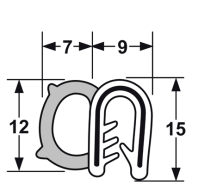
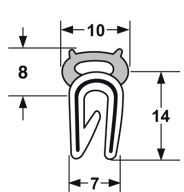
 <p>Grip Range: 1.0 - 3.0 mm</p> <p>PW-60-051SCH</p>	 <p>Grip Range: 1.0 - 2.0 mm</p> <p>PW-60-052SCH</p>	 <p>Grip Range: 1.0 - 3.0 mm</p> <p>PW-60-053SCH</p>	 <p>Grip Range: 1.0 - 2.0 mm</p> <p>PW-60-057SCH</p>	
---	---	---	---	--

PVC/EPDM SPONGE

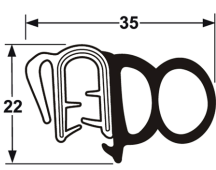
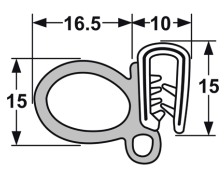
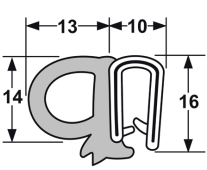
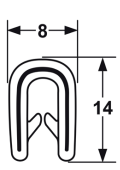
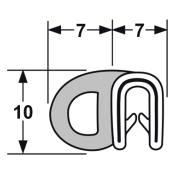
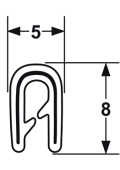
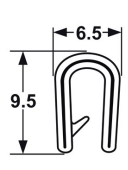
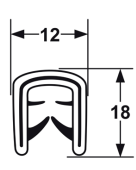
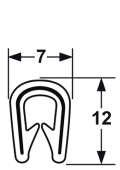
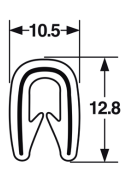
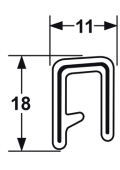
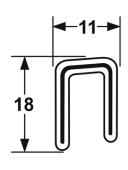
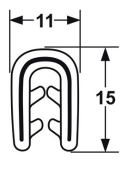
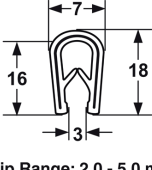
 <p>Grip Range: 1.0 - 3.0 mm</p> <p>PW-39-8844B</p>	 <p>Grip Range: 1.0 - 3.0 mm</p> <p>PW-60-054</p>	 <p>Grip Range: 1.0 - 2.5 mm</p> <p>PW-60-055N (black)</p>	 <p>Grip Range: 1.0 - 2.5 mm</p> <p>PW-60-056B (black)</p>	 <p>Grip Range: 1.0 - 2.0 mm</p> <p>PW-60-058 (black)</p>
 <p>Grip Range: 1.0 - 2.0 mm</p> <p>PW-60-059 (black)</p>	 <p>Grip Range: 1.0 - 2.5 mm</p> <p>PW-60-063 (black)</p>	 <p>Grip Range: 2.0 - 5.0 mm</p> <p>#PW-60-800 (camel) PW-60-801(charcoal) PW-60-802 (blue/grey)</p>	 <p>Grip Range: 1.0 - 2.5 mm</p> <p>PW-66-035</p>	 <p>Grip Range: 1.0 - 3.0 mm</p> <p>PW-60-037</p>
 <p>Grip Range: 4.0 - 6.0 mm</p> <p>PW-66-083 (black)</p>	 <p>Grip Range: 6.0 - 8.0 mm</p> <p>PW-66-084 (black)</p>	 <p>Grip Range: 1.0 - 3.0 mm</p> <p>PW-66-173 (black) #PW-66-176 (grey)</p>	 <p>Grip Range: 2.0 - 5.0 mm</p> <p>PW-66-8295 (black) PW-66-8296 (white)</p>	

The materials listed above have been tested to comply with the requirements of FMVSS302. Submitted samples shall not burn, nor transmit a flame front across its surface at a rate of more than 102mm per minute. All dimensions listed are mm. Stock coil length is 50m. # Non stock line - minimum order quantities apply.

TPR DUCTING

Constructed from a Thermo Plastic Rubber compound with a steel spiral helix. TPR is a good choice multipurpose ducting with excellent flexibility, U.V and abrasive resistant characteristics. TPR also has good resistance to many chemicals and oils.

Temperature Range: -50 - 120°C



I.D. (mm)	COIL (m)	PART #	CUT
38	10	PD-TR038	✓
50	20	PD-TR050	✓
57	10	PD-TR057	✓
63	20	PD-TR063	✓
75	20	PD-TR075	✓
90	10	PD-TR090	✓
100	15	PD-TR100	✓
115	10	PD-TR115	✓
125	15	PD-TR125	✓
140	10	PD-TR140	✓
150	15	PD-TR150	✓
160	10	PD-TR160	✓
180	15	PD-TR180	✓
200	10	PD-TR200	✓
230	10	PD-TR230	✓
250	10	PD-TR250	✓
300	10	PD-TR300	✓

POLYURETHANE ANTI-STATIC DUCTING

PU-AS is a light weight and flexible product that can be used as both a duct and a vacuum/delivery hose. Made from abrasion resistant polyurethane with copper wire helix, applications include suction and discharge of powders, dust, fumes, shavings and light duty industrial and abrasive applications. PU-AS is suitable for food contact in dry applications.

Temperature Range: -20 - 80°C

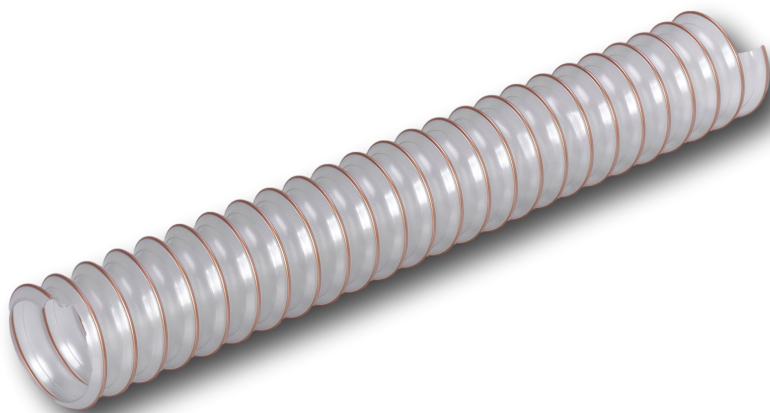

I.D. (mm)	COIL (m)	PART #	CUT
38	10	PD-PA038	✓
50	10	PD-PA050	✓
63	10	PD-PA063	✓
75	10	PD-PA075	✓
100	10	PD-PA100	✓
115	10	PD-PA115	✓
125	10	PD-PA125	✓
140	10	PD-PA140	✓
150	10	PD-PA150	✓
160	10	PD-PA160	✓
180	10	PD-PA180	✓
200	10	PD-PA200	✓
230	10	PD-PA230	✓
250	10	PD-PA250	✓
300	10	PD-PA300	✓

HOSE CLAMPS



HEAVY DUTY LINED CLAMPS

Ideal for use on soft or thin wall hoses hoses such as silicone coolant, heater and turbo hoses. Built in liner protects hose from damage while allowing high torque application for increased pressure and sealing capability. Full stainless steel construction.

RANGE (mm)	BAND WIDTH (mm)	PART #
13-23	12.7	HC-SL023
14-27	12.7	HC-SL027
17-32	14.3	HC-SL032
21-38	14.3	HC-SL038
21-44	14.3	HC-SL044
27-51	14.3	HC-SL051
33-57	14.3	HC-SL057
40-64	14.3	HC-SL064
46-70	14.3	HC-SL070
52-76	14.3	HC-SL076
59-83	14.3	HC-SL083
65-89	14.3	HC-SL089



SAFETY CLAW CLAMPS

Heavy duty clamp designed for claw couplings and any other fitting with a retaining collar.

HOSE I.D. (mm)	HOSE O.D. (mm)	PART #
12	22-27	HC-BCC012
20	28-32	HC-BCC020
25	35-42	HC-BCC025
38	45-53	HC-BCC038
50	60-73	HC-BCC050



SPRING LOADED CONSTANT TORQUE

The Constant Torque Heavy Duty Hose Clamp is a revolutionary clamp that automatically adjusts its own diameter to compensate for expansion and contraction of any vehicle hose system, maintaining consistent sealing pressure. Eliminates cold flow hose leaks and the need for regular retightening of hose clamps.

RANGE (mm)	BAND WIDTH (mm)	PART #
32-54	16	HC-CT200
45-67	16	HC-CT250
57-79	16	HC-CT300
70-92	16	HC-CT350
83-105	16	HC-CT400
95-118	16	HC-CT450



T-BOLT CLAMPS

A general purpose heavy duty clamp for use in a variety of industrial, food processing, civil and marine applications.

The bevelled edges protect the hose from damaged whilst clamping, whilst the bolt and trunion construction provides high clamping torque and improved reliability.



RANGE (mm)	W1 (Zinc Plated Steel)	W4 (Full Stainless Steel)
17-19	HC-SC1-019	HC-SC4-019
20-22	HC-SC1-022	HC-SC4-022
23-25	HC-SC1-025	HC-SC4-025
26-28	HC-SC1-028	HC-SC4-028
29-31	HC-SC1-031	HC-SC4-031
30-33	HC-SC1-033	HC-SC4-033
32-35	HC-SC1-035	HC-SC4-035
34-37	HC-SC1-037	HC-SC4-037
36-39	HC-SC1-039	HC-SC4-039
38-41		HC-SC4-041
40-43	HC-SC1-043	HC-SC4-043
42-45		HC-SC4-045
43-47	HC-SC1-047	HC-SC4-047
46-49		HC-SC4-049
47-51	HC-SC1-051	HC-SC4-051
50-53		HC-SC4-053
51-55	HC-SC1-055	HC-SC4-055
54-57		HC-SC4-057
55-59	HC-SC1-059	HC-SC4-059
58-61		HC-SC4-061
59-63	HC-SC1-063	HC-SC4-063
62-65		HC-SC4-065
63-67	HC-SC1-067	HC-SC4-067
66-70		HC-SC4-070
68-73	HC-SC1-073	HC-SC4-073
71-76		HC-SC4-076
73-79	HC-SC1-079	HC-SC4-079
77-82		HC-SC4-082
79-85	HC-SC1-085	HC-SC4-085
83-88		HC-SC4-088
85-91	HC-SC1-091	HC-SC4-091
89-94		HC-SC4-094
91-97	HC-SC1-097	HC-SC4-097
98-103	HC-SC1-103	HC-SC4-103
104-112	HC-SC1-112	HC-SC4-112
113-121	HC-SC1-121	HC-SC4-121
121-130	HC-SC1-130	HC-SC4-130
130-140	HC-SC1-140	HC-SC4-140
140-150	HC-SC1-150	HC-SC4-150
150-162	HC-SC1-162	HC-SC4-162
162-174	HC-SC1-174	HC-SC4-174

HOSE CLAMPS



WORMDRIVE CLAMPS

Hardie wormdrive hose clamps are manufactured according to DIN 3017 International Standards. Featuring smooth solid band with rolled edges for maximum hose protection and one piece offset housing delivering optimum sealing performance. These clamps are well suited to various automotive, industrial and commercial applications.



**W3 CONSTRUCTION
430 STAINLESS**



**W5 CONSTRUCTION
316 STAINLESS
MARINE GRADE**

RANGE (mm)	BAND WIDTH (mm)	PART #	RANGE (mm)	BAND WIDTH (mm)	PART #
8-12	9	HC-SS012	8-12	9	HC-W5012
8-16	9	HC-SS016	8-16	9	HC-W5016
12-20	9	HC-SS020	12-20	9	HC-W5020
			19-25	9	HC-W5025
16-27	12	HC-SS027	16-27	12	HC-W5027
20-32	12	HC-SS032	20-32	12	HC-W5032
23-35	12	HC-SS035	23-35	12	HC-W5035
25-40	12	HC-SS040	25-40	12	HC-W5040
35-50	12	HC-SS050	32-50	12	HC-W5050
40-60	12	HC-SS060	40-60	12	HC-W5060
50-70	12	HC-SS070	50-70	12	HC-W5070
60-80	12	HC-SS080	60-80	12	HC-W5080
70-90	12	HC-SS090	70-90	12	HC-W5090
80-100	12	HC-SS100	80-100	12	HC-W5100
90-110	12	HC-SS110	90-110	12	HC-W5110
100-120	12	HC-SS120			

SLOTTED BAND STAINLESS WORMDRIVE

General purpose automotive and industrial clamps. High strength 4 piece construction. Exceeds all SAE requirements.

Use for all standard clamp applications. Per SAE standard J1508 Type "F"



SIZE (SAE)	RANGE (mm)	BAND WIDTH (mm)	PART #
000 (04)	6-16	8	HC-BS016
M0 (08)	8-22	8	HC-BS022
OX (10)	14-27	12	HC-BS027
1A (12)	18-32	12	HC-BS032
1 (16)	19-38	12	HC-BS038
1X (20)	21-44	12	HC-BS044
2A (24)	27-51	12	HC-BS051
2X (32)	40-64	12	HC-BS064
3X (40)	52-76	12	HC-BS076
4 (48)	65-89	12	HC-BS089
(56)	78-102	12	HC-BS0102

O CLIPS

O clips are a simple, economical and compact solution for many applications. An O clip pincer is required to tighten O clips.



RANGE (mm)	PART #
5-7	HC-OC07
7-9	HC-OC09
9-11	HC-OC11
11-13	HC-OC13
13-15	HC-OC15
15-18	HC-OC18
17-20	HC-OC20
20-23	HC-OC23
23-27	HC-OC27
31-34	HC-OC34

FUEL LINE MINI CLIP

Ideal for use on small fuel, EFI and other automotive hose applications. The smooth band prevents hose from being damaged whilst clamping.



RANGE (mm)	PART #
6-8	HC-FL08
8-10	HC-FL10
10-13	HC-FL13
13-16	HC-FL16
15-18	HC-FL18

PIPE RETAINING CLIPS

Designed for holding hoses, tubing, cables, wires etc.

Mounting hole provided to affix clamps to frames and chassis.

Zinc plated steel with EPDM liner. 6.4mm mounting hole.



SIZE (mm)	PART #
6	HC-PRC06
10	HC-PRC10
13	HC-PRC13
16	HC-PRC16
19	HC-PRC19
22	HC-PRC22
25	HC-PRC25
27	HC-PRC27
30	HC-PRC30

HOSE CLAMPS



BANDIMEX BAND & BUCKLES

Type 201 stainless steel. Bandimex band supplied in colour coded dispensing caddy, 30m to a roll. Buckles supplied in boxes of 100 pieces.



BAND WIDTH (mm)	BAND PART #	BUCKLE PART #
6.4	HC-B202	HC-S252
9.5	HC-B203	HC-S253
12.7	HC-B204	HC-S254
15.8	HC-B205	HC-S255
19.1	HC-B206	HC-S256

HEAVY DUTY PIPE RETAINING CLAMPS - PVC LINED

Heavy duty construction. Extra thick PVC lining. Mounting hole size 10mm.

Also available in 25mm bandwidth (13mm mounting hole).



SIZE		DESCRIPTION	BAND WIDTH (mm)	MOUNTING HOLE (mm)	PACK	PART #
mm	in					
6	1/4	CC 06x19-W1-PVC	19	10	100	HC-900729-18
10	3/8	CC 10x19-W1-PVC	19	10	100	HC-900729-19
11	7/16	CC 11x19-W1-PVC	19	10	50	HC-900729-01
13	1/2	CC 13x19-W1-PVC	19	10	50	HC-900729-1
14	9/16	CC 14x19-W1-PVC	19	10	50	HC-900729-22
16	5/8	CC 16x19-W1-PVC	19	10	50	HC-900729-21
17	11/16	CC 18x19-W1-PVC	19	10	50	HC-900729-3
19	3/4	CC 19x19-W1-PVC	19	10	50	HC-900729-44
21	13/16	CC 21x19-W1-PVC	19	10	50	HC-900729-5
24	15/16	CC 24x19-W1-PVC	19	10	50	HC-900729-6
25	1	CC 25x19-W1-PVC	19	10	50	HC-900729-23
27	1-1/16	CC 27x19-W1-PVC	19	10	25	HC-900729-8

O CLIP KITS

Convenient carry tray to be able to keep in workshops and service vehicles. Holds a range of sizes of the O clips as well as a pincer for clamping. Part # HC-OC-MERCH



QTY	DESCRIPTION
1	O Clip Pincer
20	9-11mm O Clips
20	11-13mm O Clips
20	13-15mm O Clips
20	15-18mm O Clips
20	17-20mm O Clips
20	20-23mm O Clips
10	23-27mm O Clips
10	31-34mm O Clips

CAMLOCK FITTINGS - ADAPTORS

SIZE					
mm	in	Adaptor x Fem	Adaptor x Hose Tail	Adaptor x Male	Dust Plug
12	1/2	CF-AL012A	CF-AL012E	CF-AL012F	CF-AL012DP
20	3/4	CF-AL020A	CF-AL020E	CF-AL020F	CF-AL020DP
25	1	CF-AL025A	CF-AL025E	CF-AL025F	CF-AL025DP
32	1 1/4	CF-AL032A	CF-AL032E	CF-AL032F	CF-AL032DP
38	1 1/2	CF-AL038A	CF-AL038E	CF-AL038F	CF-AL038DP
50	2	CF-AL050A	CF-AL050E	CF-AL050F	CF-AL050DP
63	2 1/2	CF-AL063A	CF-AL063E	CF-AL063F	CF-AL063DP
75	3	CF-AL075A	CF-AL075E	CF-AL075F	CF-AL075DP
100	4	CF-AL100A	CF-AL100E	CF-AL100F	CF-AL100DP
150	6	CF-AL150A	CF-AL150E	CF-AL150F	CF-AL150DP

CAMLOCK FITTINGS - COUPLINGS

SIZE					
mm	in	Camlock x Male	Camlock x Hose Tail	Camlock x Fem	Dust Cap
12	1/2	CF-AL012B	CF-AL012C	CF-AL012D	CF-AL012DC
20	3/4	CF-AL020B	CF-AL020C	CF-AL020D	CF-AL020DC
25	1	CF-AL025B	CF-AL025C	CF-AL025D	CF-AL025DC
32	1 1/4	CF-AL032B	CF-AL032C	CF-AL032D	CF-AL032DC
38	1 1/2	CF-AL038B	CF-AL038C	CF-AL038D	CF-AL038DC
50	2	CF-AL050B	CF-AL050C	CF-AL050D	CF-AL050DC
63	2 1/2	CF-AL063B	CF-AL063C	CF-AL063D	CF-AL063DC
75	3	CF-AL075B	CF-AL075C	CF-AL075D	CF-AL075DC
100	4	CF-AL100B	CF-AL100C	CF-AL100D	CF-AL100DC
150	6	CF-AL150B	CF-AL150C	CF-AL150D	CF-AL150DC

CAMLOCKS - STAINLESS STEEL



CAMLOCK FITTINGS - ADAPTORS

SIZE					
mm	in	Adaptor x Fern	Adaptor x Hose Tail	Adaptor x Male	Dust Plug
20	3/4	CF-SS020A	CF-SS020E	CF-SS020F	CF-SS020DP
25	1	CF-SS025A	CF-SS025E	CF-SS025F	CF-SS025DP
32	1 1/4	CF-SS032A	CF-SS032E	CF-SS032F	CF-SS032DP
38	1 1/2	CF-SS038A	CF-SS038E	CF-SS038F	CF-SS038DP
50	2	CF-SS050A	CF-SS050E	CF-SS050F	CF-SS050DP
63	2 1/2	CF-SS063A	CF-SS063E	CF-SS063F	CF-SS063DP
75	3	CF-SS075A	CF-SS075E	CF-SS075F	CF-SS075DP
100	4	CF-SS100A	CF-SS100E	CF-SS100F	CF-SS100DP
150	6	CF-SS150A	CF-SS150E	CF-SS150F	CF-SS150DP

CAMLOCK FITTINGS - COUPLINGS

SIZE					
mm	in	Camlock x Male	Camlock x Hose Tail	Camlock x Fern	Dust Cap
20	3/4	CF-SS020B	CF-SS020C	CF-SS020D	CF-SS020DC
25	1	CF-SS025B	CF-SS025C	CF-SS025D	CF-SS025DC
32	1 1/4	CF-SS032B	CF-SS032C	CF-SS032D	CF-SS032DC
38	1 1/2	CF-SS038B	CF-SS038C	CF-SS038D	CF-SS038DC
50	2	CF-SS050B	CF-SS050C	CF-SS050D	CF-SS050DC
63	2 1/2	CF-SS063B	CF-SS063C	CF-SS063D	CF-SS063DC
75	3	CF-SS075B	CF-SS075C	CF-SS075D	CF-SS075DC
100	4	CF-SS100B	CF-SS100C	CF-SS100D	CF-SS100DC
150	6	CF-SS150B	CF-SS150C	CF-SS150D	CF-SS150DC

CAMLOCK FITTINGS - ADAPTORS

SIZE					
mm	in	Adaptor x Fem	Adaptor x Hose Tail	Adaptor x Male	Dust Plug
20	3/4	CF-PP020A	CF-PP020E	CF-PP020F	CF-PP020DP
25	1	CF-PP025A	CF-PP025E	CF-PP025F	CF-P025DP
32	1 1/4	CF-PP032A	CF-PP032E	CF-PP032F	CF-PP032DP
38	1 1/2	CF-PP038A	CF-PP038E	CF-PP038F	CF-PP038DP
50	2	CF-PP050A	CF-PP050E	CF-PP050F	CF-PP050DP
75	3	CF-PP075A	CF-PP075E	CF-PP075F	CF-PP075DP
100	4	CF-PP100A	CF-PP100E	CF-PP100F	CF-PP100DP

CAMLOCK FITTINGS - COUPLINGS

SIZE					
mm	in	Camlock x Male	Camlock x Hose Tail	Camlock x Fem	Dust Cap
20	3/4	CF-PP020B	CF-PP020C	CF-PP020D	CF-PP020DC
25	1	CF-PP025B	CF-PP025C	CF-PP025D	CF-PP025DC
32	1 1/4	CF-PP032B	CF-PP032C	CF-PP032D	CF-PP032DC
38	1 1/2	CF-PP038B	CF-PP038C	CF-PP038D	CF-PP038DC
50	2	CF-PP050B	CF-PP050C	CF-PP050D	CF-PP050DC
75	3	CF-PP075B	CF-PP075C	CF-PP075D	CF-PP075DC
100	4	CF-PP100B	CF-PP100C	CF-PP100D	CF-PP100DC



CAMLOCKS - NYGLASS



CAMLOCK FITTINGS - ADAPTORS

SIZE					
mm	in	Adaptor x Fem	Adaptor x Hose Tail	Adaptor x Male	Dust Plug
20	3/4	CF-NG020A	CF-NG020E	CF-NG020F	CF-NG020DP
25	1	CF-NG025A	CF-NG025E	CF-NG025F	CF-NG025DP
32	1 1/4	CF-NG032A	CF-NG032E	CF-NG032F	CF-NG032DP
38	1 1/2	CF-NG038A	CF-NG038E	CF-NG038F	CF-NG038DP
50	2	CF-NG050A	CF-NG050E	CF-NG050F	CF-NG050DP
75	3	CF-NG075A	CF-NG075E	CF-NG075F	CF-NG075DP

CAMLOCK FITTINGS - COUPLINGS

SIZE					
mm	in	Camlock x Male	Camlock x Hose Tail	Camlock x Fem	Dust Cap
20	3/4	CF-NG020B	CF-NG020C	CF-NG020D	CF-NG020DC
25	1	CF-NG025B	CF-NG025C	CF-NG025D	CF-NG025DC
32	1 1/4	CF-NG032B	CF-NG032C	CF-NG032D	CF-NG032DC
38	1 1/2	CF-NG038B	CF-NG038C	CF-NG038D	CF-NG038DC
50	2	CF-NG050B	CF-NG050C	CF-NG050D	CF-NG050DC
75	3	CF-NG075B	CF-NG075C	CF-NG075D	CF-NG075DC

INDUSTRIAL NYLON - IMPERIAL & METRIC

Lightweight and versatile nylon tubing has excellent dimensional stability and can save as much as 75% in weight over rubber hose and steel tubing. UV and temperature stabilised, it also offers excellent resistance to petrol, diesel, oil, grease, brake fluids and other chemicals.

IMPERIAL		METRIC		WORKING PRESSURE (psi)	BURST PRESSURE (psi)	CUT	
O.D. (in)	PART #	O.D. (mm)	PART #			BLACK	COLOURS
1/8	NT-IM-02***	4	NT-ME-04***	250	1000	✓	✗
3/16	NT-IM-03***	5	NT-ME-05***	250	1000	✓	✗
1/4	NT-IM-04***	6	NT-ME-06***	250	1000	✓	✗
5/16	NT-IM-05***	8	NT-ME-08***	250	1000	✓	✗
3/8	NT-IM-06***	10	NT-ME-10***	250	1000	✓	✗
1/2	NT-IM-08***	12	NT-ME-12***	250	1000	✓	✗
5/8	NT-IM-10***			125	500	✗	✗
3/4	NT-IM-12***			125	500	✗	✗



SEMI RIGID NYLON - IMPERIAL & METRIC

Available in black in 100m rolls only.

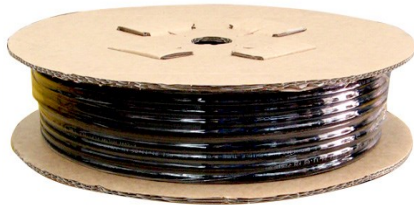

O.D. (in)	PRESSURE (psi)	PART #	CUT
1/8	625	NT-SR02-100	✗
3/16	625	NT-SR03-100	✗
1/4	625	NT-SR04-100	✗
5/16	625	NT-SR05-100	✗
3/8	625	NT-SR06-100	✗
1/2	625	NT-SR08-100	✗
4mm	625	NT-SRM4-100	✗
6mm	625	NT-SRM6-100	✗

LOW DENSITY POLYETHYLENE

LDPE tubing is chemically inert, meets AS2070 (food contact) and has good resistance to most chemicals and solvents. Available in natural in 100m coils. Max working pressure 116psi. Max temp 60°C.

O.D. (mm)	PART #	CUT	O.D. (in)	PART #	CUT
4	AT-LDM04-100	✗	3/16	AT-LDI03-100	✗
5	AT-LDM05-100	✗	1/4	AT-LDI04-100	✗
6	AT-LDM06-100	✗	5/16	AT-LDI05-100	✗
8	AT-LDM08-100	✗	3/8	AT-LDI06-100	✗
10	AT-LDM10-100	✗	1/2	AT-LDI08-100	✗
12	AT-LDM12-100	✗	5/8	AT-LDI10-100	✗



TUBING - PU & AIR BRAKE



POLYURETHANE TUBING

PU tubing is extremely flexible with a small bend radius for routing into tight spaces. Highly kink and abrasion resistant, it withstands abuse that would damage other plastic tubing. Available in blue.



O.D. (mm)	PART #	PRESSURE (psi)	COIL (m)	CUT
4	AT-PM04***	130	100	✓
6	AT-PM06***	130	200	✓
8	AT-PM08***	130	100	✓
10	AT-PM10***	130	100	✓
12	AT-PM12**	130	100	✓

SUZI COIL SETS

Set consists of 1x red coil & 1x blue coil fitted with springs and 1/2in male ends. Meets SAE J844 and DOT standards.



O.D. (in)	LENGTH (m)	TAIL	PART #
1/2	3.0	Standard	NT-ABSUZI-STD
1/2	3.7	Long	NT-ABSUZI-LONG

NYLON AIR BRAKE TUBING - IMPERIAL

Imperial nylon air brake tubing is manufactured in accordance with SAE J844 specifications. Available in sizes 1/8 through to 3/4in, in black, blue and red. Type A SAE J844 tubes are single wall construction. Type B SAE J844 tubes (3/8in and larger) are double wall construction with nylon core, synthetic fibre braid and nylon cover.



O.D. (in)	PART #	MIN BURST PRESSURE (psi)	COIL (m)	CUT	
				BLACK	COLOURS
1/4	NT-IJ844-04***	1200	25 100	✓	✗
3/8	NT-IJ844-06***	1400	25 100	✓	✗
1/2	NT-IJ844-08***	950	25 100	✓	✗
5/8	NT-IJ844-10***	900	25	✗	✗
3/4	NT-IJ844-12***	800	25	✗	✗

NYLON AIR BRAKE TUBING - METRIC

Metric nylon air brake tubing is manufactured in accordance with DIN 74324 specifications. Available in sizes 6mm through to 16mm in black only.



O.D. (mm)	I.D. (mm)	PART #	COIL (m)	CUT
6	4	NT-MDIN-06***	25 100	✓
8	6	NT-MDIN-08***	25 100	✓
10	7.5	NT-MDIN-10***	25 100	✓
12	9	NT-MDIN-12***	25 100	✗
16	12	NT-MDIN-16***	25 100	✗

AIR BRAKE HOSE - SAE J1402 A

Synthetic rubber hose for use in air brake systems. Commonly used for air supply to brake boosters on maxi brake systems. Temp range -46°C to +100°C.

Crimped assemblies available.





I.D. (mm)	O.D. (mm)	PRESSURE (psi)	REEL (m)	PART #	CUT
10	19	225	76 - 152	AH-AB010	✓
12	22	225	76 - 152	AH-AB012	✓

PUSH FIT - D.O.T AIR BRAKE

PUSH IN - IMPERIAL TUBE x NPT THREAD

Tube OD	NPT				
in	in				
5/32	1/8	TF-AF3-02502	TF-AF5-02502		
3/16	1/8	TF-AF3-0302	TF-AF5-0302		
1/4	1/8	TF-AF3-0402	TF-AF5-0402	TF-AF10-0402	TF-AF12-0402
1/4	1/4	TF-AF3-0404	TF-AF5-0404	TF-AF10-0404	TF-AF12-0404
1/4	3/8	TF-AF3-0406	TF-AF5-0406		
3/8	1/4	TF-AF3-0604	TF-AF5-0604	TF-AF10-0604	TF-AF12-0604
3/8	3/8	TF-AF3-0606	TF-AF5-0606	TF-AF10-0606	TF-AF12-0606
3/8	1/2	TF-AF3-0608	TF-AF5-0608	TF-AF10-0608	TF-AF12-0608
1/2	1/4	TF-AF3-0804	TF-AF5-0804	TF-AF10-0804	
1/2	3/8	TF-AF3-0806	TF-AF5-0806	TF-AF10-0806	TF-AF12-0806
1/2	1/2	TF-AF3-0808	TF-AF5-0808	TF-AF10-0808	TF-AF12-0808
5/8	1/2	TF-AF3-1008	TF-AF5-1008		
3/4	1/2	TF-AF3-1208	TF-AF5-1208		
3/4	3/4	TF-AF3-1212	TF-AF5-1212		

PUSH IN - IMPERIAL TUBE x IMPERIAL TUBE

Tube OD x Tube OD			
in	in		
5/32	5/32	TF-AF4-025	TF-AF14-025
3/16	3/16	TF-AF4-03	TF-AF14-03
1/4	1/4	TF-AF4-04	TF-AF14-04
3/8	3/8	TF-AF4-06	TF-AF14-06
1/2	1/2	TF-AF4-08	TF-AF14-08
5/8	5/8	TF-AF4-10	TF-AF14-10
3/4	3/4	TF-AF4-12	TF-AF14-12



METRIC TUBE - METRIC THREADS - STEP SIZES

MANY OTHER OPTIONS ALSO AVAILABLE

AIR BRAKE COUPLINGS



AIR BRAKE COUPLINGS A93 SERIES

Size	Type	Valved Coupling	Valved Adaptor	Unvalved Coupling	Unvalved Adaptor
1/4	NPT Male	AC-A93-30	AC-A93-91	AC-A93-83	AC-A93-18
3/8	NPT Male	AC-A93-31	AC-A93-92	AC-A93-84	AC-A93-19
1/2	NPT Male	AC-A93-32	AC-A93-93	AC-A93-85	AC-A93-20
1/4	NPS Female	AC-A93-33	AC-A93-88	AC-A93-86	AC-A93-21
3/8	NPS Female	AC-A93-34	AC-A93-89	AC-A93-82	AC-A93-22
1/2	NPS Female	AC-A93-35	AC-A93-90	AC-A93-87	AC-A93-23
1/4	Hose Tail				AC-A93-29
3/8	Hose Tail				AC-A93-08
1/2	Hose Tail				AC-A93-14

TUBE CLAMPS - METRIC & IMPERIAL

In almost all industrial countries and for more than 50 years, tube clamps have symbolised quick and easy pipe, tube, hose and cable installations as well as a clean distinct pipe layout.

Their vibration and noise reducing features are appreciated as being an important contribution to environmental protection and occupational health and safety.

Tube clamp applications are almost unlimited. With the broad range of styles and sizes, almost all areas of pipe, tube, hose and cable installation are covered.

- Industrial & mobile hydraulics
- Marine, oil & gas industries
- Process & chemical industries
- Food & beverage industry
- Power plants, reactors & wind energy
- Transport & utility networks
- Pneumatic & instrumentation lines
- Grease & lubrication lines

Available in polypropylene (green), nylon (black) or aluminium bodies with zinc plated steel (W3) or stainless steel (W5) hardware.

Please call our office to discuss options.



OD (mm)	OD (in)	NB Pipe	Single	Double
6.0			HC-TCS-06.0	HC-TCD-06.0
6.4	1/4		HC-TCS-06.4	HC-TCD-06.4
8.0			HC-TCS-08.0	HC-TCD-08.0
9.5	3/8		HC-TCS-09.5	HC-TCD-09.5
10.0		1/8	HC-TCS-10.0	HC-TCD-10.0
12.0			HC-TCS-12.0	HC-TCD-12.0
12.7	1/2		HC-TCS-12.7	HC-TCD-12.7
13.5		1/4	HC-TCS-13.5	HC-TCD-13.5
14.0			HC-TCS-14.0	HC-TCD-14.0
16.0	5/8		HC-TCS-16.0	HC-TCD-16.0
17.2		3/8	HC-TCS-17.2	HC-TCD-17.2
19.0	3/4		HC-TCS-19.0	HC-TCD-19.0
20.0			HC-TCS-20.0	HC-TCD-20.0
21.3		1/2	HC-TCS-21.3	HC-TCD-21.3
22.0			HC-TCS-22.0	HC-TCD-22.0
25.0			HC-TCS-25.0	HC-TCD-25.0
25.4	1		HC-TCS-25.4	HC-TCD-25.4
26.9		3/4	HC-TCS-26.9	HC-TCD-26.9
28.0			HC-TCS-28.0	HC-TCD-28.0
30.0			HC-TCS-30.0	HC-TCD-30.0
32.0	1 1/4		HC-TCS-32.0	HC-TCD-32.0
33.7		1	HC-TCS-33.7	HC-TCD-33.7
35.0			HC-TCS-35.0	HC-TCD-35.0

Sizes available up to 76.1mm OD

PUSH FIT - PNEUMATIC

PUSH IN - IMPERIAL TUBE x BSPT THREAD

Tube OD	BSPT				
in	in				
1/8	1/8	TF-QF3-0202	TF-QF5-0202		TF-QF12-0202
3/16	1/8	TF-QF3-0302	TF-QF5-0302		
1/4	1/8	TF-QF3-0402	TF-QF5-0402	TF-QF10-0402	TF-QF12-0402
	1/4	TF-QF3-0404	TF-QF5-0404	TF-QF10-0404	TF-QF12-0404
	3/8	TF-QF3-0406	TF-QF5-0406		TF-QF12-0406
5/16	1/8	TF-QF3-0502	TF-QF5-0502	TF-QF10-0502	TF-QF12-0502
	1/4	TF-QF3-0504	TF-QF5-0504	TF-QF10-0504	TF-QF12-0504
	3/8	TF-QF3-0506	TF-QF5-0506		TF-QF12-0506
3/8	1/4	TF-QF3-0604	TF-QF5-0604	TF-QF10-0604	TF-QF12-0604
	3/8	TF-QF3-0606	TF-QF5-0606	TF-QF10-0606	TF-QF12-0606
	1/2	TF-QF3-0608	TF-QF5-0608		TF-QF12-0608
1/2	1/4	TF-QF3-0804	TF-QF5-0804		TF-QF12-0804
	3/8	TF-QF3-0806	TF-QF5-0806		TF-QF12-0806
	1/2	TF-QF3-0808	TF-QF5-0808		TF-QF12-0808



ALSO AVAILABLE IN NICKEL PLATED BRASS



PUSH IN - IMPERIAL TUBE x IMPERIAL TUBE

Tube OD x Tube OD			
in	in		
1/8	1/8	TF-QF4-02	TF-QF14-02
3/16	3/16	TF-QF4-03	TF-QF14-03
1/4	1/4	TF-QF4-04	TF-QF14-04
5/16	5/16	TF-QF4-05	TF-QF14-05
3/8	3/8	TF-QF4-06	TF-QF14-06
1/2	1/2	TF-QF4-08	TF-QF14-08

PUSH FIT - PNEUMATIC



PUSH IN - METRIC TUBE x BSP THREAD

Tube OD x BSP								
mm	in							
4	1/8	TF-QFM3-0402	TF-QFM5-0402	TF-QFM10-0402	TF-QFM12-0402	TF-QFM13-0402	TF-QFM76-0402	TF-NSEM-0402
	1/4	TF-QFM3-0404	TF-QFM5-0404	TF-QFM10-0404	TF-QFM12-0404	TF-QFM13-0404	TF-QFM76-0404	TF-NSEM-0404
6	1/8	TF-QFM3-0602	TF-QFM5-0602	TF-QFM10-0602	TF-QFM12-0602	TF-QFM13-0602	TF-QFM76-0602	TF-NSEM-0602
	1/4	TF-QFM3-0604	TF-QFM5-0604	TF-QFM10-0604	TF-QFM12-0604	TF-QFM13-0604	TF-QFM76-0604	TF-NSEM-0604
	3/8	TF-QFM3-0606	TF-QFM5-0606	TF-QFM10-0606	TF-QFM12-0606	TF-QFM13-0606	TF-QFM76-0606	TF-NSEM-0606
8	1/8	TF-QFM3-0802	TF-QFM5-0802	TF-QFM10-0802	TF-QFM12-0802	TF-QFM13-0802	TF-QFM76-0802	TF-NSEM-0802
	1/4	TF-QFM3-0804	TF-QFM5-0804	TF-QFM10-0804	TF-QFM12-0804	TF-QFM13-0804	TF-QFM76-0804	TF-NSEM-0804
	3/8	TF-QFM3-0806	TF-QFM5-0806	TF-QFM10-0806	TF-QFM12-0806	TF-QFM13-0806	TF-QFM76-0806	TF-NSEM-0806
10	1/4	TF-QFM3-1004	TF-QFM5-1004	TF-QFM10-1004	TF-QFM12-1004	TF-QFM13-1004	TF-QFM76-1004	TF-NSEM-1004
	3/8	TF-QFM3-1006	TF-QFM5-1006	TF-QFM10-1006	TF-QFM12-1006	TF-QFM13-1006	TF-QFM76-1006	TF-NSEM-1006
	1/2	TF-QFM3-1008	TF-QFM5-1008	TF-QFM10-1008	TF-QFM12-1008	TF-QFM13-1008	TF-QFM76-1008	TF-NSEM-1008
12	1/4	TF-QFM3-1204	TF-QFM5-1204	TF-QFM10-1204	TF-QFM12-1204	TF-QFM13-1204	TF-QFM76-1204	TF-NSEM-1204
	3/8	TF-QFM3-1206	TF-QFM5-1206	TF-QFM10-1206	TF-QFM12-1206	TF-QFM13-1206	TF-QFM76-1206	TF-NSEM-1206
	1/2	TF-QFM3-1208	TF-QFM5-1208	TF-QFM10-1208	TF-QFM12-1208	TF-QFM13-1208	TF-QFM76-1208	TF-NSEM-1208
16	3/8	TF-QFM3-1606	TF-QFM5-1606		TF-QFM12-1606	TF-QFM13-1606	TF-QFM76-1606	TF-NSEM-1606
	1/2	TF-QFM3-1608	TF-QFM5-1608	TF-QFM10-1608	TF-QFM12-1608	TF-QFM13-1608	TF-QFM76-1608	TF-NSEM-1608

PUSH IN - METRIC TUBE x METRIC TUBE







Tube OD x Tube OD							
mm	mm						
4	4	TF-QFM4-04	TF-QFM11-04	TF-QFM14-04	TF-QFM31-04	TF-QFM75-04	TF-NSFM-04
6	6	TF-QFM4-06	TF-QFM11-06	TF-QFM14-06	TF-QFM31-06	TF-QFM75-06	TF-NSFM-06
8	8	TF-QFM4-08	TF-QFM11-08	TF-QFM14-08	TF-QFM31-08	TF-QFM75-08	TF-NSFM-08
10	10	TF-QFM4-10	TF-QFM11-10	TF-QFM14-10	TF-QFM31-10	TF-QFM75-10	TF-NSFM-10
12	12	TF-QFM4-12	TF-QFM11-12	TF-QFM14-12	TF-QFM31-12	TF-QFM75-12	TF-NSFM-12
16	16	TF-QFM4-16	TF-QFM11-16	TF-QFM14-16	TF-QFM31-16	TF-QFM75-16	TF-NSFM-16

STRAIGHT ADAPTORS

BSP x BSP							
in	in	M x F	F x F	M x M	F x F	F x M	M x M
1/8	1/8		BF-26-02	BF-27-02		BF-72-0202	
1/4	1/8	BF-24-0402			BF-29-0402	BF-72-0402	BF-73-0402
1/4	1/4		BF-26-04	BF-27-04		BF-72-0404	
3/8	1/8	BF-24-0602			BF-29-0602	BF-72-0602	BF-73-0602
3/8	1/4	BF-24-0604			BF-29-0604	BF-72-0604	BF-73-0604
3/8	3/8		BF-26-06	BF-27-06		BF-72-0606	
1/2	1/8	BF-24-0802			BF-29-0802	BF-72-0802	BF-73-0802
1/2	1/4	BF-24-0804			BF-29-0804	BF-72-0804	BF-73-0804
1/2	3/8	BF-24-0806			BF-29-0806	BF-72-0806	BF-73-0806
1/2	1/2		BF-26-08	BF-27-08		BF-72-0808	
3/4	1/4	BF-24-1204			BF-29-1204		BF-73-1204
3/4	3/8	BF-24-1206			BF-29-1206		BF-73-1206
3/4	1/2	BF-24-1208			BF-29-1208	BF-72-1208	BF-73-1208
3/4	3/4		BF-26-12	BF-27-12		BF-72-1212	
1	1/4	BF-24-1604					
1	3/8	BF-24-1606					
1	1/2	BF-24-1608					BF-73-1608
1	3/4	BF-24-1612			BF-29-1612	BF-72-1612	BF-73-1612
1	1		BF-26-16	BF-27-16		BF-72-1616	

ELBOWS & TEES





CAPS, PLUGS & NUTS

BSP x BSP							
in	in	M x F	F x F	F x F x F	CAP	PLUG	NUT
1/8	1/8	BF-25-02	BF-34-02	BF-35-02	BF-33-02	BF-64-02	BF-74-02
1/4	1/4	BF-25-04	BF-34-04	BF-35-04	BF-33-04	BF-64-04	BF-74-04
3/8	3/8	BF-25-06	BF-34-06	BF-35-06	BF-33-06	BF-64-06	BF-74-06
1/2	1/2	BF-25-08	BF-34-08	BF-35-08	BF-33-08	BF-64-08	BF-74-08
3/4	3/4	BF-25-12	BF-34-12	BF-35-12	BF-33-12	BF-64-12	BF-74-12
1	1	BF-25-16	BF-34-16	BF-35-16	BF-33-16	BF-64-16	BF-74-16
1 1/4	1 1/4	BF-25-20	BF-34-20	BF-35-20	BF-33-20	BF-64-20	
1 1/2	1 1/2	BF-25-24	BF-34-24	BF-35-24	BF-33-24	BF-64-24	BF-74-24
2	2	BF-25-32	BF-34-32	BF-35-32	BF-33-32	BF-64-32	
2 1/2	2 1/2					BF-64-40	



HOSE TAILS - BRASS





BRASS HOSE TAILS - THREADED

Hose Tail x BSP						
in	in					
1/8	1/8	BF-P3-0202				
3/16	1/8	BF-P3-0302	BF-P6-0302	BF-P10-0302	BF-P12-0302	
3/16	1/4	BF-P3-0304	BF-P6-0304			
1/4	1/8	BF-P3-0402	BF-P6-0402	BF-P10-0402	BF-P12-0402	
1/4	1/4	BF-P3-0404	BF-P6-0404	BF-P10-0404	BF-P12-0404	
1/4	3/8	BF-P3-0406	BF-P6-0406			
5/16	1/8	BF-P3-0502	BF-P6-0502	BF-P10-0502	BF-P12-0502	
5/16	1/4	BF-P3-0504	BF-P6-0504	BF-P10-0504	BF-P12-0504	
5/16	3/8	BF-P3-0506	BF-P6-0506	BF-P10-0506		
5/16	1/2	BF-P3-0508	BF-P6-0508			
3/8	1/8	BF-P3-0602	BF-P6-0602	BF-P10-0602	BF-P12-0602	
3/8	1/4	BF-P3-0604	BF-P6-0604	BF-P10-0604	BF-P12-0604	
3/8	3/8	BF-P3-0606	BF-P6-0606	BF-P10-0606	BF-P12-0606	
3/8	1/2	BF-P3-0608	BF-P6-0608		BF-P12-0608	
1/2	1/8	BF-P3-0802				
1/2	1/4	BF-P3-0804	BF-P6-0804	BF-P10-0804	BF-P12-0804	
1/2	3/8	BF-P3-0806	BF-P6-0806	BF-P10-0806	BF-P12-0806	
1/2	1/2	BF-P3-0808	BF-P6-0808	BF-P10-0808	BF-P12-0808	IF-BNT12
1/2	3/4	BF-P3-0812	BF-P6-0812			IF-BNT17
1/2	1	BF-P3-0816				
5/8	1/4	BF-P3-1004	BF-P6-1004	BF-P10-1004		
5/8	3/8	BF-P3-1006	BF-P6-1006	BF-P10-1006	BF-P12-1006	
5/8	1/2	BF-P3-1008	BF-P6-1008			
3/4	3/8	BF-P3-1206				
3/4	1/2	BF-P3-1208	BF-P6-1208	BF-P10-1208	BF-P12-1208	
3/4	3/4	BF-P3-1212	BF-P6-1212	BF-P10-1212	BF-P12-1212	IF-BNT20
3/4	1	BF-P3-1216				IF-BNT23
1	3/4	BF-P3-1612	BF-P6-1612			
1	1	BF-P3-1616	BF-P6-1616		BF-P12-1616	IF-BNT25
1	1 1/4	BF-P3-1620				IF-BNT27
1 1/4	1	BF-P3-2016				
1 1/4	1 1/4	BF-P3-2020				IF-BNT32
1 1/4	1 1/2	BF-P3-2024				
1 1/2	1 1/4	BF-P3-2420				
1 1/2	1 1/2	BF-P3-2424				IF-BNT38
1 1/2	2	BF-P3-2432				IF-BNT47
2	2	BF-P3-3232				IF-BNT50
2 1/2	2 1/2	BF-P3-4040				
3	3	BF-P3-4848				
4	4	BF-P3-6464				

JOINERS & TEES

Hose Tail x Hose Tail				
in	in			
3/16	3/16	BF-P7-03	BF-P11-03	BF-P14-03
1/4	1/4	BF-P7-04	BF-P11-04	BF-P14-04
5/16	5/16	BF-P7-05	BF-P11-05	BF-P14-05
3/8	3/8	BF-P7-06	BF-P11-06	BF-P14-06
1/2	1/2	BF-P7-08	BF-P11-08	BF-P14-08
5/8	5/8	BF-P7-10	BF-P11-10	BF-P14-10
3/4	3/4	BF-P7-12	BF-P11-12	BF-P14-12
1	1	BF-P7-16		BF-P14-16

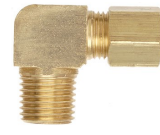
COMPRESSION FITTINGS

Tube O.D. x BSPT Male				Tube O.D. x Tube O.D.			
in	in			in	in		
3/16	1/8	TF-3-0302	TF-5-0302	3/16	3/16	TF-4-03	TF-14-03
3/16	1/4	TF-3-0304	TF-5-0304	1/4	1/4	TF-4-04	TF-14-04
1/4	1/8	TF-3-0402	TF-5-0402	5/16	5/16	TF-4-05	TF-14-05
1/4	1/4	TF-3-0404	TF-5-0404	3/8	3/8	TF-4-06	TF-14-06
5/16	1/8	TF-3-0502	TF-5-0502	1/2	1/2	TF-4-08	TF-14-08
5/16	1/4	TF-3-0504	TF-5-0504				
3/8	1/4	TF-3-0604	TF-5-0604				
3/8	3/8	TF-3-0606	TF-5-0606				
1/2	3/8	TF-3-0806	TF-5-0806				
1/2	1/2	TF-3-0808	TF-5-0808				

MERCHANDISERS





Ask us about displays and merchandisers tailored to your requirements.



HOSE TAILS - STAINLESS



STAINLESS STEEL HOSE TAILS

Hose Tail x BSP						
in	in	Male BSPT	Male BSPT Elbow	Female BSPP (Fixed)	Hose Joiner	Hose Tee
1/4	1/4	SF-P3-0404	SF-P6-0404	SF-P10-0404		
5/16	1/4	SF-P3-0504				
5/16	3/8	SF-P3-0506				
3/8	1/4	SF-P3-0604				
3/8	3/8	SF-P3-0606	SF-P6-0606	SF-P10-0606	SF-P7-0606	SF-P14-0606
3/8	1/2	SF-P3-0608				
1/2	1/4	SF-P3-0804				
1/2	3/8	SF-P3-0806				
1/2	1/2	SF-P3-0808	SF-P6-0808	SF-P10-0808	SF-P7-0808	SF-P14-0808
1/2	3/4	SF-P3-0812				
5/8	1/2	SF-P3-1008				
3/4	1/2	SF-P3-1208				
3/4	3/4	SF-P3-1212	SF-P6-1212	SF-P10-1212	SF-P7-1212	SF-P14-1212
3/4	1	SF-P3-1216				
1	3/4	SF-P3-1612				
1	1	SF-P3-1616	SF-P6-1616	SF-P10-1616	SF-P7-1616	SF-P14-1616
1 1/4	1	SF-P3-2016				
1 1/4	1 1/4	SF-P3-2020	SF-P6-2020	SF-P10-2020	SF-P7-2020	SF-P14-2020
1 1/2	1	SF-P3-2416				
1 1/2	1 1/4	SF-P3-2420				
1 1/2	1 1/2	SF-P3-2424	SF-P6-2424	SF-P10-2424	SF-P7-2424	SF-P14-2424
2	1 1/2	SF-P3-3224				
2	2	SF-P3-3232	SF-P6-3232	SF-P10-3232	SF-P7-3232	SF-P14-3232

HOSE TAILS - HYGIENIC

BSM RJT (RING JOINT THREAD) & BSM CIP (FLAT FACE)

Connection x Hose Tail								
in	mm	BSM RJT Male (O Ring Seal)	BSM RJT Female (O Ring Seal)	BSM CIP Male (Flat Face)	BSM CIP Female (Flat Face)	BSM Nut (RJT & CIP)	BSM RJT Seal (NBR)	BSM CIP Seal (NBR)
1 x 1	25 x 25	FG-RJM025	FG-RJF025	FG-CIM025	FG-CIF025	FG-BSN025	FG-RJS025	FG-CIS025
1.5 x 1.5	38 x 38	FG-RJM038	FG-RJF038	FG-CIM038	FG-CIF038	FG-BSN038	FG-RJS038	FG-CIS038
2 x 2	51 x 51	FG-RJM050	FG-RJF050	FG-CIM050	FG-CIF050	FG-BSN050	FG-RJS050	FG-CIS050
2 x 1	51 x 25		FG-RJF050025					
2 x 1.5	51 x 38		FG-RJF050038					
2.5 x 2.5	63 x 63	FG-RJM063	FG-RJF063	FG-CIM063	FG-CIF063	FG-BSN063	FG-RJS063	FG-CIS063
3 x 2	76 x 51		FG-RJF075050			FG-BSN075	FG-RJS075	FG-CIS075
3 x 3	76 x 76	FG-RJM075	FG-RJF075	FG-CIM075	FG-CIF075			
4 x 4	102 x 102	FG-RJM100	FG-RJF100	FG-CIM100	FG-CIF100	FG-BSN100	FG-RJS100	FG-CIS100

TRICLOVER, AUSTRALIAN WINE & CRIMP FERRULES

Connection x Hose Tail								
in	mm	Triclover	Triclover Clamp	Triclover Seal (NBR)	Australian Wine Male	Australian Wine Female	Aust. Wine Seal (NBR)	Crimp Ferrules
1 x 1	25 x 25	FG-TRI025	FG-TRC025	FG-TRS025				FG-CFH025
1.5 x 1.5	38 x 38	FG-TRI038	FG-TRC038	FG-TRS038				FG-CFH038
2 x 2	51 x 51	FG-TRI050	FG-TRC050	FG-TRS050	FG-AWM050	FG-AWF050	FG-AWS050	FG-CFH050
2.5	63	FG-TRI063	FG-TRC063					FG-CFH063
3	76	FG-TRI075	FG-TRC075	FG-TRS075	FG-AWM075	FG-AWF075	FG-AWS075	FG-CFH075
4	102	FG-TRI100	FG-TRC100	FG-TRS100	FG-AWM100	FG-AWF100	FG-AWS100	FG-CFH100

**CUSTOM FITTINGS, SPECIAL SEALS,
HOSE & THREAD PROTECTORS ALSO AVAILABLE**

PIPE FITTINGS - STAINLESS



SCREWED ADAPTORS

BSP x BSP				
in	in	M x F	F x F	M x M
1/4	1/8	SF-24-0402	SF-29-0402	SF-73-0402
3/8	1/8	SF-24-0602	SF-29-0602	SF-73-0602
3/8	1/4	SF-24-0604	SF-29-0604	SF-73-0604
1/2	1/4	SF-24-0804	SF-29-0804	SF-73-0804
1/2	3/8	SF-24-0806	SF-29-0806	SF-73-0806
3/4	3/8	SF-24-1206	SF-29-1206	SF-73-1206
3/4	1/2	SF-24-1208	SF-29-1208	SF-73-1208
1	1/2	SF-24-1608	SF-29-1608	SF-73-1608
1	3/4	SF-24-1612	SF-29-1612	SF-73-1612
1 1/4	3/4	SF-24-2012	SF-29-2012	SF-73-2012
1 1/4	1	SF-24-2016	SF-29-2016	SF-73-2016
1 1/2	1	SF-24-2416	SF-29-2416	SF-73-2416
1 1/2	1 1/4	SF-24-2420	SF-29-2420	SF-73-2420
2	1	SF-24-3216	SF-29-3216	SF-73-3216
2	1 1/4	SF-24-3220	SF-29-3220	SF-73-3220
2	1 1/2	SF-24-3224	SF-29-3224	SF-73-3224

ELBOWS & TEES

BSP x BSP								
in	in	M x F	F x F	M x M	F x F	F x F x F	M	M x WELD
1/8	1/8	SF-25-02	SF-26-02	SF-27-02	SF-34-02	SF-35-02	SF-64-02	SF-88-02
1/4	1/4	SF-25-04	SF-26-04	SF-27-04	SF-34-04	SF-35-04	SF-64-04	SF-88-04
3/8	3/8	SF-25-06	SF-26-06	SF-27-06	SF-34-06	SF-35-06	SF-64-06	SF-88-06
1/2	1/2	SF-25-08	SF-26-08	SF-27-08	SF-34-08	SF-35-08	SF-64-08	SF-88-08
3/4	3/4	SF-25-12	SF-26-12	SF-27-12	SF-34-12	SF-35-12	SF-64-12	SF-88-12
1	1	SF-25-16	SF-26-16	SF-27-16	SF-34-16	SF-35-16	SF-64-16	SF-88-16
1 1/4	1 1/4	SF-25-20	SF-26-20	SF-27-20	SF-34-20	SF-35-20	SF-64-20	SF-88-20
1 1/2	1 1/2	SF-25-24	SF-26-24	SF-27-24	SF-34-24	SF-35-24	SF-64-24	SF-88-24
2	2	SF-25-32	SF-26-32	SF-27-32	SF-34-32	SF-35-32	SF-64-32	SF-88-32

TANK FITTING

BSP x BSP		
in	in	
3/4	1/2	SF-STF-1208
1	3/4	SF-STF-1612
1 1/4	1	SF-STF-2016
1 1/2	1 1/4	SF-STF-2420
2	1 1/2	SF-STF-3224

SKIN FITTING

BSP	
in	
1/2	SF-SK-08
3/4	SF-SK-12
1	SF-SK-16
1 1/4	SF-SK-20
1 1/2	SF-SK-24
2	SF-SK-32
2 1/2	SF-SK-40
3	SF-SK-48
4	SF-SK-64



Many other fittings available in a variety of sizes upon request



PIPE FITTINGS - POLY



STRAIGHT FITTINGS

BSP					
mm	in	F x F	M x M	F x F x F	M
15	1/2	PF-26-08	PF-27-08	PF-35-08	PF-64-08
20	3/4	PF-26-12	PF-27-12	PF-35-12	PF-64-32
25	1	PF-26-16	PF-27-16	PF-35-16	PF-64-16
32	1 1/4	PF-26-20	PF-27-20	PF-35-20	PF-64-20
40	1 1/2	PF-26-24	PF-27-24	PF-35-24	PF-64-24
50	2	PF-26-32	PF-27-32	PF-35-32	PF-64-32
65	2 1/2	PF-26-40	PF-27-40	PF-35-40	PF-64-40
80	3	PF-26-48	PF-27-48	PF-35-48	PF-64-48

REDUCING FITTINGS

BSP			
mm	mm	M x F	M x M
15	10	PF-24-0806	
20	15	PF-24-1208	PF-73-1208
25	15	PF-24-1608	PF-73-1608
25	20	PF-24-1612	PF-73-1612
32	20	PF-24-2012	PF-73-2012
32	25	PF-24-2016	PF-73-2016
40	20	PF-24-2412	PF-73-2412
40	25	PF-24-2416	PF-73-2416
40	32	PF-24-2420	PF-73-2420
50	20	PF-24-3212	PF-73-3212
50	25	PF-24-3216	PF-73-3216
50	32	PF-24-3220	PF-73-3220
50	40	PF-24-3224	PF-73-3224
65	32	PF-24-4020	PF-73-4020
65	40	PF-24-4024	PF-73-4024
65	50	PF-24-4032	PF-73-4032
80	40	PF-24-4824	PF-73-4824
80	50	PF-24-4832	PF-73-4832
80	65	PF-24-4840	PF-73-4840

ELBOWS

BSP			
mm	in	M x F	F x F
15	1/2	PF-25-08	PF-34-08
20	3/4	PF-25-12	PF-34-12
25	1	PF-25-16	PF-34-16
32	1 1/4	PF-25-20	PF-34-20
40	1 1/2	PF-25-24	PF-34-24
50	2	PF-25-32	PF-34-32
65	2 1/2	PF-25-40	PF-34-40
80	3	PF-25-48	PF-34-48

IBC ADAPTOR

S60x6 female fits most IBC valves to convert to 50mm BSP Female.

Polypropylene fitting with santoprene washer.



Part # IF-IBC050



POLYPROPYLENE HOSE TAILS - BSP THREADS

Hose Tail x BSP					
mm	in	BSPT Male	BSPP Female (Washer)	BSPT Male Elbow	BSPT Male Branch Tee
12	1/2	PF-P3-0808	PF-P5W-0808	PF-P6-0808	PF-P12-0808
20	3/4	PF-P3-1212	PF-P5W-1212	PF-P6-1212	PF-P12-1212
25	1	PF-P3-1616	PF-P5W-1616	PF-P6-1616	PF-P12-1616
32	1 1/4	PF-P3-2020	PF-P5W-2020	PF-P6-2020	PF-P12-2020
38	1 1/2	PF-P3-2424	PF-P5W-2424	PF-P6-2424	PF-P12-2424
50	2	PF-P3-3232	PF-P5W-3232	PF-P6-3232	PF-P12-3232
75	3	PF-P3-4848	PF-P5W-4848	PF-P6-4848	PF-P12-4848

POLYPROPYLENE HOSE TAILS - JOINERS & TEES

Hose Tail				
mm	in	Straight	Elbow	Tee
12	1/2	PF-P7-08	PF-P11-08	PF-P14-08
20	3/4	PF-P7-12	PF-P11-12	PF-P14-12
25	1	PF-P7-16	PF-P11-16	PF-P14-16
32	1 1/4	PF-P7-20	PF-P11-20	PF-P14-20
38	1 1/2	PF-P7-24	PF-P11-24	PF-P14-24
50	2	PF-P7-32	PF-P11-32	PF-P14-32
75	3	PF-P7-48	PF-P11-48	PF-P14-48

PIPE FITTINGS - GAL MAL



BENDS & ELBOWS

BSP						
mm	in	F x F	F x F	F x F	M x F	M x F
12	1/2	GF-BFF90015	GF-EFF45015	GF-EFF90015	GF-EMF45015	GF-EMF90015
20	3/4	GF-BFF90020	GF-EFF45020	GF-EFF90020	GF-EMF45020	GF-EMF90020
25	1	GF-BFF90025	GF-EFF45025	GF-EFF90025	GF-EMF45025	GF-EMF90025
32	1 1/4	GF-BFF90032	GF-EFF45032	GF-EFF90032	GF-EMF45032	GF-EMF90032
38	1 1/2	GF-BFF90040	GF-EFF45040	GF-EFF90040	GF-EMF45040	GF-EMF90040
50	2	GF-BFF90050	GF-EFF45050	GF-EFF90050	GF-EMF45050	GF-EMF90050
63	2 1/2	GF-BFF90065	GF-EFF45065	GF-EFF90065		GF-EMF90065
75	3	GF-BFF90080	GF-EFF45080	GF-EFF90080		GF-EMF90080
100	4	GF-BFF90100	GF-EFF45100	GF-EFF90100		GF-EMF90100
150	6			GF-EFF90150		



NIPPLES, SOCKETS, CAPS, PLUGS & TEES

BSP						
mm	in	F	M x M	M	F x F	F x F x F
12	1/2	GF-C015	GF-HN015	GF-P015	GF-S015	GF-T015
20	3/4	GF-C020	GF-HN020	GF-P020	GF-S020	GF-T020
25	1	GF-C025	GF-HN025	GF-P025	GF-S025	GF-T025
32	1 1/4	GF-C032	GF-HN032	GF-P032	GF-S032	GF-T032
38	1 1/2	GF-C040	GF-HN040	GF-P040	GF-S040	GF-T040
50	2	GF-C050	GF-HN050	GF-P050	GF-S050	GF-T050
63	2 1/2	GF-C065	GF-HN065	GF-P063	GF-S065	GF-T065
75	3	GF-C080	GF-HN080	GF-P080	GF-S080	GF-T080
100	4	GF-C100	GF-HN100	GF-P100	GF-S100	GF-T100
150	6		GF-HN150	GF-P150	GF-S150	

BACK NUTS, UNIONS, FLANGES & HOSE TAILS

BSP						
mm	in	F	F x F	F	Gasket	Male x Hose Tail
12	1/2	GF-BN015	GF-UBSFF015	GF-FD015	GF-FG015	IF-CBP015
20	3/4	GF-BN020	GF-UBSFF020	GF-FD020	GF-FG020	IF-CBP020
25	1	GF-BN025	GF-UBSFF025	GF-FD025	GF-FG025	IF-CBP025
32	1 1/4	GF-BN032	GF-UBSFF032	GF-FD032	GF-FG032	IF-CBP032
38	1 1/2	GF-BN040	GF-UBSFF040	GF-FD040	GF-FG038	IF-CBP040
50	2	GF-BN050	GF-UBSFF050	GF-FD050	GF-FG050	IF-CBP050
63	2 1/2	GF-BN065	GF-UBSFF065	GF-FD065	GF-FG063	IF-CBP065
75	3	GF-BN080	GF-UBSFF080	GF-FD080	GF-FG075	IF-CBP080
100	4	GF-BN100	GF-UBSFF100	GF-FD100	GF-FG100	IF-CBP100
150	6			GF-FD150	GF-FG150	IF-CBP100

REDUCING BUSHES, NIPPLES & SOCKETS

BSP				
in	in	M x F	M x M	F x F
1/2	3/8	GF-RB015010	GF-RN015010	
3/4	1/2	GF-RB020015	GF-RN020015	GF-RS020015
1	1/2	GF-RB025015	GF-RN025015	GF-RS025015
1	3/4	GF-RB025020	GF-RN025020	GF-RS025020
1 1/4	3/4	GF-RB032020	GF-RN032020	
1 1/4	1	GF-RB032025	GF-RN032025	GF-RS032025
1 1/2	1	GF-RB040025	GF-RN040025	GF-RS040025
1 1/2	1 1/4	GF-RB040032	GF-RN040032	GF-RS040032
2	1	GF-RB050025	GF-RN050025	GF-RS050025
2	1 1/4	GF-RB050032	GF-RN050032	GF-RS050032
2	1 1/2	GF-RB050040	GF-RN050040	GF-RS050040
2 1/2	2	GF-RB065050	GF-RN065050	GF-RS065050
3	2	GF-RB080050	GF-RN080050	GF-RS080050
3	2 1/2	GF-RB080065	GF-RN080065	GF-RS080065
4	2	GF-RB100050	GF-RN100050	
4	3	GF-RB100080	GF-RN100080	GF-RS100080
6	4	GF-RB150100		





FIRE FITTINGS







STORZ FITTINGS

SIZE						
Storz (in)	Tail/Thread (in)	Hose Tail	BSP Male	BSP Female	Blanking Cap w/ Chain	Spanner
1	3/4	IF-STZ025-020H	IF-STZ025-020M	IF-STZ025-020F		
1	1	IF-STZ025H	IF-STZ025M	IF-STZ025F	IF-STZ025C	IF-STZSP025
1 1/2	1 1/2	IF-STZ038H	IF-STZ038M	IF-STZ038F	IF-STZ038C	IF-STZSP063
2	2	IF-STZ050H	IF-STZ050M	IF-STZ050F	IF-STZ050C	IF-STZSP063
2 1/2	1 1/2	IF-STZ063-038H	IF-STZ063-038M	IF-STZ063-038F		
2 1/2	2	IF-STZ063-050H	IF-STZ063-050M	IF-STZ063-050F		
2 1/2	2 1/2	IF-STZ063H	IF-STZ063M	IF-STZ063F	IF-STZ063C	IF-STZSP063
3	3	IF-STZ075H	IF-STZ075M	IF-STZ075F	IF-STZ075C	IF-STZSP075
4	4	IF-STZ100H	IF-STZ100M	IF-STZ100F	IF-STZ100C	IF-STZSP100
5	5	IF-STZ125H		IF-STZ125F	IF-STZ125C	
6	6	IF-STZ150H	IF-STZ150M	IF-STZ150F	IF-STZ150C	IF-STZSP150

FIRE FITTINGS - CFA 2-1/2in x 3 TPI

SIZE					
Tail/Thrd. (in)	CFA Female x Hose Tail	CFA Female x BSP Female	CFA Female x BSPT Male	CFA Male x Hose Tail	CFA Male x BSPT Male
1 1/2	IF-CFAF038H	IF-CFAF038FB	IF-CFAF038MB	IF-CFAM038H	IF-CFAM038MB
2	IF-CFAF050H	IF-CFAF050FB	IF-CFAF050MB	IF-CFAM050H	IF-CFAM050MB
2 1/2	IF-CFAF063H	IF-CFAF063FB	IF-CFAF063MB	IF-CFAM063H	IF-CFAM063MB
3	IF-CFAF075H	IF-CFAF075FB	IF-CFAF075MB	IF-CFAM075H	IF-CFAM075MB

FIRE FITTINGS - MFB 2-1/2in x 5 TPI

SIZE				
Tail/Thrd. (in)	MFB Female x Hose Tail	MFB Female x BSP Female	MFB Male x Hose Tail	MFB Male x BSPT Male
1 1/2	IF-MFBF038H	IF-MFBF038FB	IF-MFBM038H	IF-MFBM038MB
2	IF-MFBF050H	IF-MFBF050FB	IF-MFBM050H	IF-MFBM050MB
2 1/2	IF-MFBF063H	IF-MFBF063FB	IF-MFBM063H	IF-MFBM063MB
3	IF-MFBF075H	IF-MFBF075FB	IF-MFBM075H	IF-MFBM075MB

STANDPIPES

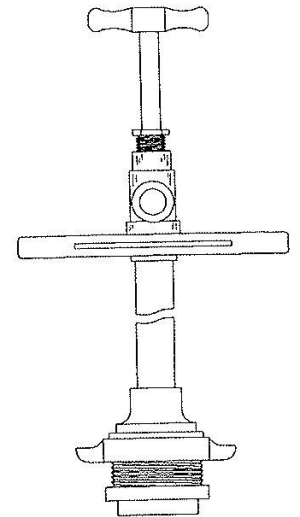

STANDPIPES
ALSO
AVAILABLE

BAUER TYPE COUPLINGS

Bauer Type Couplings are quick action fittings with four parts - the male ball, closure ring, female socket & sealing ring.

A single movement engages and locks the coupling, compressing the sealing ring to ensure a leakproof joint under either suction or delivery applications. The spherical construction of the ball and socket ensures the seal is equally efficient at coupling angles up to 30°.

SIZE						
Nominal (in)	Nominal (mm)	Ball O.D (mm)	Bauer Type Male x Hose Tail	Bauer Type Female x Hose Tail	Closure Ring	Sealing Ring
2	50	70	IF-BCG050MH	IF-BCG050FH	IF-BCG050CR	IF-BCG050CS
3	75	98	IF-BCG075MH	IF-BCG075FH	IF-BCG075CR	IF-BCG075CS
4	100	144	IF-BCG100MH	IF-BCG100FH	IF-BCG100CR	IF-BCG100CS
6	150	180	IF-BCG150MH	IF-BCG150FH	IF-BCG150CR	IF-BCG150CS
8	200	230	IF-BCG200MH	IF-BCG200FH	IF-BCG200CR	IF-BCG200CS
SIZE						
Nominal (in)	Nominal (mm)	Ball O.D (mm)	Bauer Type Female x Table D Flange	Bauer Type Male x Table D Flange (inc. closure ring)	Bauer Type Female x BSP Male	Bauer Type Male x BSP Male
4	100	144	IF-BCG100FF	IF-BCG100MF	IF-BCG100FB	IF-BCG100MB
6	150	180	IF-BCG150FF	IF-BCG150MF	IF-BCT150FB	IF-BCG150MB
8	200	230	IF-BCG200FF	IF-BCG200MF	IF-BCG200FB	IF-BCG200MB

STRAINERS & NOZZLES

STRAINERS

SIZE			
mm	POLY STRAINER HOSETAIL	GAL STRAINER HOSETAIL	GAL STRAINER BSP FEMALE
32	IF-PS032		
38	IF-PS038		
50	IF-PS050	IF-GAS050	IF-GSB050
75		IF-GAS075	IF-GSB075
100		IF-GAS100	IF-GSB100

NOZZLES - PLASTIC & BRASS

SIZE					
mm	HIGH FLOW NOZZLE HOSE TAIL	FIRE HOSE NOZZLE HOSE TAIL	VIPER NOZZLE BSP FEMALE	BRASS NOZZLE HOSE TAIL	BRASS FOG NOZZLE CLICK ON / BSP FEM
20	NG-PJ020	NG-FN020		NG-BN020	NG-B18FOG
25	NG-PJ025	NG-FN025	NG-VN025	NG-BN025	
38			NG-VN038		







BLUE WASHDOWN GUN

The Hardie Blue Washdown gun is a heavy duty hot or cold water wash down gun brass body. With adjustable spray pattern, it is suitable for wash down in dairies, creameries, factories, commercial kitchens or any industrial area in need of wash down.







Body	Chromed brass
Inlet	1/2in BSPF
Flow rate	60 l/min
Max pressure rating	10 bar (150 PSI)
Max temperature	90°C
Part #	NG-HWG-012









NITTO STYLE 'ONE TOUCH' COUPLINGS

						
in	COUPLING FEMALE	COUPLING MALE	COUPLING HOSE TAIL	ADAPTOR FEMALE	ADAPTOR MALE	ADAPTOR HOSE TAIL
1/4	AC-NT20SF	AC-NT20SM	AC-NT20SH	AC-NT20PF	AC-NT20PM	AC-NT20PH
5/16			AC-NT25SH			AC-NT25PH
3/8	AC-NT30SF	AC-NT30SM	AC-NT30SH	AC-NT30PF	AC-NT30PM	AC-NT30PH
1/2	AC-NT40SF	AC-NT40SM	AC-NT40SH	AC-NT40PF	AC-NT40PM	AC-NT40PH



RYCO STYLE COUPLINGS

						
in	COUPLING FEMALE	COUPLING MALE	COUPLING HOSE TAIL	ADAPTOR FEMALE	ADAPTOR MALE	ADAPTOR HOSE TAIL
1/4	AC-RE20SF	AC-RE20SM	AC-RE20SH	AC-RE20PF	AC-RE20PM	AC-RE20PH
3/8	AC-RE30SF	AC-RE30SM	AC-RE30SH	AC-RE30PF	AC-RE30PM	AC-RE30PH
1/2	AC-RE40SF	AC-RE40SM	AC-RE40SH	AC-RE40PF	AC-RE40PM	AC-RE40PH

JAMEC STYLE COUPLINGS

						
in	COUPLING FEMALE	COUPLING MALE	COUPLING HOSE TAIL	ADAPTOR FEMALE	ADAPTOR MALE	ADAPTOR HOSE TAIL
1/4	AC-JE20SF	AC-JE20SM	AC-JE20SH	AC-JE20PF	AC-JE20PM	AC-JE20PH
3/8	AC-JE30SF	AC-JE30SM	AC-JE30SH	AC-JE30PF	AC-JE30PM	AC-JE30PH
1/2	AC-JE40SF	AC-JE40SM	AC-JE40SH	AC-JE40PF	AC-JE40PM	AC-JE40PH



CLAW COUPLINGS - TYPE A

			
in	Male	Female	Hose Tail
1/2	IF-QA012M	IF-QA012F	IF-QA012H
3/4	IF-QA020M	IF-QA020F	IF-QA020H
1	IF-QA025M	IF-QA025F	IF-QA025H



HYDRAULIC FITTINGS



ISO 7241-1 SERIES A

		
in	Male Adaptor BSPP Female	Female Coupling BSPP Female
1/4	HF-QC102-0404FB	HF-QC101-0404FB
3/8	HF-QC102-0606FB	HF-QC101-0606FB
1/2	HF-QC102-0808FB	HF-QC101-0808FB
3/4	HF-QC102-1212FB	HF-QC101-1212FB
1	HF-QC102-1616FB	HF-QC101-1616FB

AGRICULTURAL INTERCHANGE

		
in	Male Adaptor BSPP Female	Female Coupling BSPP Female
1/4	HF-QC302-0404FB	HF-QC301-0404FB
3/8	HF-QC302-0606FB	HF-QC301-0606FB
1/2	HF-QC102-0808FB	HF-QC101-0808FB
3/4	HF-QC302-1212FB	HF-QC301-1212FB
1	HF-QC302-1616FB	HF-QC301-1616FB

ISO 16028 FLAT FACE

		
in	Male Adaptor BSPP Female	Female Coupling BSPP Female
1/4	HF-QC502-0404FB	HF-QC501-0404FB
3/8	HF-QC502-0606FB	HF-QC501-0606FB
1/2	HF-QC502-0808FB	HF-QC501-0808FB
3/4	HF-QC502-1212FB	HF-QC501-1212FB
1	HF-QC502-1616FB	HF-QC501-1616FB

TEMA INTERCHANGE

		
in	Male Adaptor BSPP Female	Female Coupling BSPP Female
1/4	HF-QC402-0404FB	HF-QC401-0404FB
3/8	HF-QC402-0606FB	HF-QC401-0606FB
1/2	HF-QC402-0808FB	HF-QC401-0808FB
3/4	HF-QC402-1212FB	HF-QC401-1212FB
1	HF-QC402-1616FB	HF-QC401-1616FB

FIELD ATTACHABLE HOSE FITTINGS

Shells			BSP Threads			JIC Threads						
	Hose	1 Wire	Hose	Thread	BSPT Male Straight	BSPP Female Straight	BSP Female 90deg Elbow	Hose	Thread	JIC Male Straight	JIC Female Straight	JIC Female 90deg Elbow
1/4	HF-R-F104	HF-R-F204	1/4	1/4	HF-R-FA0404BT	HF-R-FA0404BPF	HF-R-FA0404BPF90T	1/4	7/16	HF-R-FA0404MJ	HF-R-FA0404FJ	HF-R-FA0404FJ90T
3/8	HF-R-F106	HF-R-F206	3/8	3/8	HF-R-FA0606BT	HF-R-FA0606BPF	HF-R-FA0606BPF90T	1/4	9/16	HF-R-FA0406MJ	HF-R-FA0406FJ	HF-R-FA0406FJ90T
1/2	HF-R-F108	HF-R-F208	1/2	1/2	HF-R-FA0808BT	HF-R-FA0808BPF	HF-R-FA0808BPF90T	3/8	9/16	HF-R-FA0606MJ	HF-R-FA0606FJ	HF-R-FA0606FJ90T
3/4	HF-R-F112	HF-R-F212	3/4	3/4	HF-R-FA1212BT	HF-R-FA1212BPF	HF-R-FA1212BPF90T	3/8	3/4	HF-R-FA0608MJ	HF-R-FA0608FJ	HF-R-FA0608FJ90T
1	HF-R-F116	HF-R-F216	1	1	HF-R-FA1616BT	HF-R-FA1616BPF	HF-R-FA1616BPF90T	1/2	3/4	HF-R-FA0808MJ	HF-R-FA0808FJ	HF-R-FA0808FJ90T
								1/2	7/8	HF-R-FA0810MJ	HF-R-FA0810FJ	HF-R-FA0810FJ90T
								3/4	1-1/16	HF-R-FA1212MJ	HF-R-FA1212FJ	HF-R-FA1212FJ90T
								1	1-5/16	HF-R-FA1616MJ	HF-R-FA1616FJ	HF-R-FA1616FJ90T

O-RING ASSORTMENT KITS

Description	Part #
Caterpillar O-Ring Kit 90A 580pcs	HA-MK-OR-CAT01
Caterpillar D-Ring Kit 90A 80pcs	HA-MK-OR-CAT02
Hitachi O-Ring Kit 90A 383pcs	HA-MK-OR-HIT
Komatsu O-Ring Kit 90A 435pcs	HA-MK-OR-KOM
Imperial O-Ring Kit 90A 382pcs (also available in 70A)	HA-MK-OR-I90
Metric O-Ring Kit 90A 382pcs (also available in 70A)	HA-MK-OR-M90



GENERAL PURPOSE BRASS BALL VALVE

Full bore valve with female BSPP ports. Plated brass body with stainless steel lever handle. Suitable for use with air, water, oils, fuels and chemicals. Sizes 1/4in to 4in.



SIZE (in)	PART #
1/4	BV-GP006
3/8	BV-GP010
1/2	BV-GP012
3/4	BV-GP020
1	BV-GP025
1 1/4	BV-GP032
1 1/2	BV-GP038
2	BV-GP050
3	BV-GP075
4	BV-GP100

BRASS BIBCOCK BALL VALVE

Full bore valve with male BSP thread and hose barb spout. Plated brass body with stainless steel handle. An economical solution for decanting from drums, tanks & troughs.



SIZE (in)	PART #
1/2	BV-BC012
3/4	BV-BC020
1	BV-BC025

BRASS MINI & T-HANDLE BALL VALVES

Nickel plated brass. Suitable for air, water, oil, and chemicals. Stainless steel available upon request.



SIZE (in)	MINI Female x Female	MINI Male x Female	T-HANDLE Female x Female	T-HANDLE Male x Female
1/8	BV-M002	BV-M002MF		
1/4	BV-M006	BV-M006MF	BV-TH006	BV-TH006MF
3/8	BV-M010	BV-M010MF	BV-TH010	BV-TH010MF
1/2	BV-M012	BV-M012MF	BV-TH012	BV-TH012MF
3/4			BV-TH020	BV-TH020MF
1			BV-TH025	BV-TH025MF

VALVES



BRASS VALVES



SIZE (in)	GATE VALVE	FOOT VALVE	SPRING CHECK	SWING CHECK	Y STRAINER
3/8			BV-SP010		BV-Y010
1/2	BV-G012	BV-FV012	BV-SP012	BV-SW012	BV-Y012
3/4	BV-G020	BV-FV020	BV-SP020	BV-SW020	BV-Y020
1	BV-G025	BV-FV025	BV-SP025	BV-SW025	BV-Y025
1 1/4	BV-G032	BV-FV032	BV-SP032	BV-SW032	BV-Y032
1 1/2	BV-G038	BV-FV038	BV-SP038	BV-SW038	BV-Y038
2	BV-G050	BV-FV050	BV-SP050	BV-SW050	BV-Y050
2 1/2	BV-G063	BV-FV063	BV-SP063	BV-SW063	BV-Y063
3	BV-G075	BV-FV075	BV-SP075	BV-SW075	BV-Y075
4	BV-G100	BV-FV100	BV-SP100	BV-SW100	BV-Y100

STAINLESS STEEL VALVES



SIZE (in)	BALL VALVE (FULL BORE)	SPRING CHECK	SWING CHECK	Y STRAINER
1/4	BV-S2006	BV-SV006		
3/8	BV-S2010	BV-SV010		BV-SY010
1/2	BV-S2012	BV-SV012	BV-SC012	BV-SY012
3/4	BV-S2020	BV-SV020	BV-SC020	BV-SY020
1	BV-S2025	BV-SV025	BV-SC025	BV-SY025
1 1/4	BV-S2032	BV-SV032	BV-SC032	BV-SY032
1 1/2	BV-S2038	BV-SV038	BV-SC038	BV-SY038
2	BV-S2050	BV-SV050	BV-SC050	BV-SY050

BRASS GARDEN TAPS

145psi working pressure.



INLET (in)	OUTLET (in)	PART #
1/2	3/4	GR-BT012
3/4	1	GR-BT020

BALL VALVE NOZZLE

Durable nickel plated brass body, suitable for cold and warm water washdown in applications where a simple, compact and economical nozzle is required.



SIZE (in)	PART #
1/2	BV-RBN012
3/4	BV-RBN020
1	BV-RBN025

BUTTERFLY & WAFER CHECK VALVES

SIZE (in)		
2	BV-WF050	BV-WC050
2 1/2	BV-WF063	BV-WC063
3	BV-WF075	BV-WC075
4	BV-WF100	BV-WC100
5	BV-WF125	BV-WC125
6	BV-WF150	BV-WC150
8	BV-WF200	BV-WC200
10	BV-WF250	BV-WC250

OTHER VALVES AVAILABLE

3 WAY L & T PORT	ACTUATED	STRAINERS	3PC STAINLESS CHECK	PVC BALL VALVES
				

PRESSURE GAUGES

Liquid filled stainless steel case with brass stem and copper bourdon tube. Suitable for air, water, oil, fuel and mild chemicals. Bottom entry connection with dual scale psi/bar in 63mm and 100mm dials.

63MM DIAL - 1/4 BSP				100MM DIAL - 3/8 BSP	
RANGE (psi)	PART #	RANGE (psi)	PART #	RANGE (psi)	PART #
0-15	PG-LF0630015	0-350	PG-LF0630350	0-36	PG-LF1000036
0-35	PG-LF0630035	0-600	PG-LF0630600	0-116	PG-LF1000116
0-60	PG-LF0630060	0-1000	PG-LF0631000	0-230	PG-LF1000230
0-90	PG-LF0630090	0-1500	PG-LF0631500	0-580	PG-LF1000580
0-100	PG-LF0630100	0-3000	PG-LF0633000	0-1160	PG-LF1001160
0-150	PG-LF0630150	0-3600	PG-LF0633600	0-3600	PG-LF1003600
0-200	PG-LF0630200	0-6000	PG-LF0636000	0-6000	PG-LF1006000
0-230	PG-LF0630230				



HOSE STANDS



HOSE MERCHANDISER STAND

Versatile, compact hose stand suitable for displaying our broad range of merchandiser reels. Provides convenient access to our most popular products, and can be tailored to suit your needs with any combination of the products below.

PART #	MERCHANDISER REEL
AH-CH012020MR	Car Heater Hose 12mm (1/2) x 20m
AH-CH016020MR	Car Heater Hose 16mm (5/8) x 20m
AH-FL005030MR	Automotive Fuel Hose 4.8mm (3/16) x 30m
AH-FL006025MR	Automotive Fuel Hose 6.3mm (1/4) x 25m
AH-FL008025MR	Automotive Fuel Hose 7.9mm (5/16) x 25m
AH-FL010025MR	Automotive Fuel Hose 9.5mm (3/8) x 25m
AH-FL012030MR	Automotive Fuel Hose 12.7mm (1/2) x 30m
CH-003200MR	Clear Vinyl Food/Petrol 3mm x 200m
CH-004100MR	Clear Vinyl Food/Petrol 4mm x 100m
CH-005100MR	Clear Vinyl Food/Petrol 5mm x 100m
CH-006100MR	Clear Vinyl Food/Petrol 6mm x 100m
CH-008100MR	Clear Vinyl Food/Petrol 8mm x 100m
CH-010075MR	Clear Vinyl Food/Petrol 10mm x 75m
CH-012050MR	Clear Vinyl Food/Petrol 12mm x 50m
CH-016030MR	Clear Vinyl Food/Petrol 16mm x 30m
PH-CA010040MR	Dual Blue PVC Air/Chemical 10mm x 40m
PH-CA012030MR	Dual Blue PVC Air/Chemical 12mm x 30m
PH-CM006050MR	PVC Hardie Clear Multipurpose 6mm x 50m
PH-CM008050MR	PVC Hardie Clear Multipurpose 8mm x 50m
PH-CM010040MR	PVC Hardie Clear Multipurpose 10mm x 40m
PH-CM012030MR	PVC Hardie Clear Multipurpose 12mm x 30m
PH-CM016020MR	PVC Hardie Clear Multipurpose 16mm x 20m
PH-SU006060MR	Multiflex Airhose AS2554B 6mm x 60m
PH-SU008050MR	Multiflex Airhose AS2554B 8mm x 50m
PH-WH012020MR	Blue Stripe Washdown 12mm x 20m
RH-MF006030MR	Marine Fuel Line USCG 6mm x 30m
RH-MF008030MR	Marine Fuel Line USCG 8mm x 30m
RH-MF010030MR	Marine Fuel Line USCG 10mm x 30m
RH-MF012015MR	Marine Fuel Line USCG 12mm x 15m
RH-MF016015MR	Marine Fuel Line USCG 16mm x 15m
RH-MP005050MR	Red Multipurpose 300psi 5mm x 50m
RH-MP006040MR	Red Multipurpose 400psi 6mm x 40m
RH-MP008030MR	Red Multipurpose 400psi 8mm x 30m
RH-MP010030MR	Red Multipurpose 400psi 10mm x 30m
RH-MP012020MR	Red Multipurpose 400psi 12mm x 20m
RH-PL010025MR	SAE100R6 Lock On Hose 3/8 x 25m



NATURAL INSERTION RUBBER

Natural insertion rubber is designed for use as a general purpose strip, pad, lining or gasket and is mainly used for sealing, insulating, isolating and protecting steel or other surfaces.

It can be used in a wide range of applications including flange gaskets on pipes and tanks, insulating strip, isolation barriers, dust seals and covers and many other general purpose sealing applications.

Available in 10m rolls & various widths.

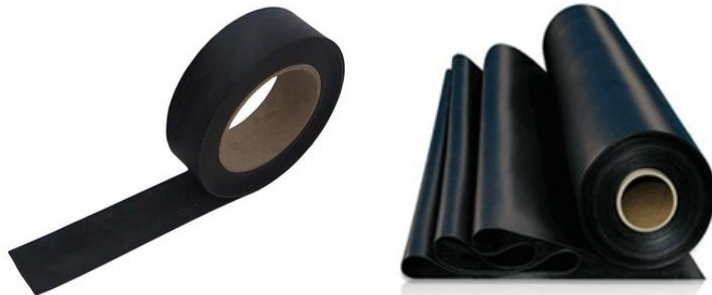

PLY	THICKNESS (mm)	50mm WIDE 10m ROLL	75mm WIDE 10m ROLL	100mm WIDE 10m ROLL	150mm WIDE 10m ROLL	1200mm WIDE 10m ROLL	CUT
1	1.5	SR-IRS001050-010	SR-IRS001075-010	SR-IRS001100-010	SR-IRS001150-010	SR-IR01-010	×
1	3.0	SR-IRS003050-010	SR-IRS003075-010	SR-IRS003100-010	SR-IRS003150-010	SR-IR03-010	×
2	4.5					SR-IR04-010	×
2	6.0	SR-IRS006050-010	SR-IRS006075-010	SR-IRS006100-010	SR-IRS006150-010	SR-IR06-010	×
2	9.0					SR-IR09-010	×

EQUINE RUBBER FLOOR MATTING

Equine rubber floor matting is a premium grade, durable and impact resistant 65 Duro synthetic rubber matting designed for use as a non-slip floor matting for horse floats, transport trucks and stables. Supplied with a turtle-back finish on the top surface for anti-slip assurance even when wet and reinforced with a heavy nylon fabric to provide superior tear resistance.

Equine rubber floor matting is also insulating and anti-fatigue, reducing the need for extra bedding in stalls and will reduce fatigue to horses in areas where they stand for long periods of time. The mat has a textured fabric finish on the underside to allow for easy bonding to floors but is also heavy enough to lay flat when simply rolled out into position.

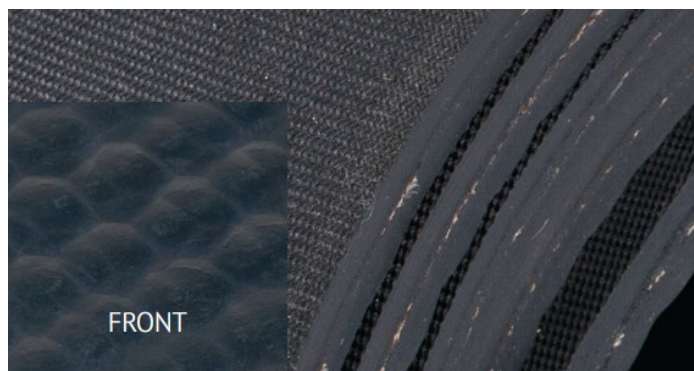

THICKNESS (mm)	WIDTH (mm)	LENGTH (m)	PART #	CUT
8.0	2000	10	SR-EQ08200010	×

COMPRESSED AIR PIPING



PE100 AIR PIPE





Australian made from quality virgin polyethylene, our PE100 poly air pipe is non corrosive, non toxic, has a high resistance to impact and is manufactured to AS/NZS 4130. Coloured blue for easy identification, compliant with the requirements of AS1345.



The perfect choice for your compressed air system.

PIPE O.D. (mm)	NOMINAL BORE (in)	MAX. SUPPORT DISTANCE (m)	WEIGHT (kg/m)	LENGTH (m)	PART #	CUT
20	1/2	0.50	0.12	6.0	KA-A1	✘
25	3/4	0.75	0.19	6.0	KA-A2	✘
32	1	1.00	0.32	6.0	KA-A3	✘
40	1 1/4	1.25	0.51	6.0	KA-A4	✘
50	1 1/2	1.50	0.79	6.0	KA-A5	✘

POLYPROPYLENE COMPRESSION FITTINGS - PN16

PIPE O.D. (mm)	BSP THREAD (in)					
		MALE BSP	FEMALE BSP	MALE ELBOW	FEMALE ELBOW	FEMALE TEE
20	1/2	KA-MA112	KA-FA112	KA-ETM112	KA-ETF112	KA-TTF112
25	3/4	KA-MA220	KA-FA220	KA-ETM220	KA-ETF220	KA-TTF220
32	1	KA-MA325	KA-FA325	KA-ETM325	KA-ETF325	KA-TTF325
40	1 1/4	KA-MA432	KA-FA432	KA-ETM432	KA-ETF432	KA-TTF432
50	1 1/2	KA-MA540	KA-FA540	KA-ETM540	KA-ETF540	KA-TTF540

PIPE O.D. (mm)	PIPE O.D. (mm)					
		UNION	ELBOW	TEE	REDUCING BRANCH TEE	SUPPORT CLIP
20	20	KA-C1	KA-E1	KA-T1		KA-CSC20
25	20				KA-T21	
25	25	KA-C2	KA-E2	KA-T2		KA-CSC25
32	25				KA-T32	
32	32	KA-C3	KA-E3	KA-T3		KA-CSC32
40	32				KA-T43	
40	40	KA-C4	KA-E4	KA-T4		KA-CSC40
50	40				KA-T54	
50	50	KA-C5	KA-E5	KA-T5		KA-CSC50



HARDIE **HOSE**

RUBBER HOSE • PVC HOSE

LAYFLAT HOSE • BRASS FITTINGS

CAMLOCKS • VALVES • HOSE REELS

POLY FITTINGS • STAINLESS FITTINGS

HYDRAULIC FITTINGS • NOZZLES • AND MUCH MORE!

3 TITAN DRIVE

CARRUM DOWNS

VIC 3201

P: (03) 9708 2887

F: (03) 9011 9641

E: SALES@HARDIEHOSE.COM